

Autofix - Automated Design of Fixtures

S. Nambiar^{1,✉}, A. P. Albert¹, V. V. R. C. Rimmalapudi¹, V. Acharya¹, M. Tarkian¹
and H. Kihlman²

¹ Linköping University, Sweden, ² Prodtex AB, Sweden

✉ sanjay.nambiar@liu.se

Abstract

This paper presents a framework to develop the automated design of fixtures using the combination of design automation (DA), multidisciplinary optimization and robotic simulation. MDO necessitates the use of concurrent and parametric designs which are created by DA and knowledge-based engineering tools. This approach is designed to decrease the time and cost of the fixture design process by increasing the degree of automation. AutoFix provides methods and tools for automatically optimizing resource-intensive fixture design utilizing digital tools from different disciplines.

Keywords: design automation, design optimisation, knowledge-based engineering (KBE), fixtures, robotic simulation

1. Introduction

In manufacturing industries and production firms, operations like welding, bonding, and assembling require the work-piece to be located and held successfully with external forces. Fixture is a work holding device which ensures that the work-piece produced will maintain conformity and interchangeability. The design of fixture has a significant impact on product quality in terms of machined part precision, accuracy, and finish. The design is influenced by a number of factors, including the work-piece, machining techniques, material properties and so on. It necessitates the designer's extensive experience, which results in a significant increase in design cycle time and costs. However, dimensioning inaccuracies, which are linked to poor fixture design, account for around 40% of all rejected parts (Hashemi, Shaharoun, Izman, 2014).

Fixture design is primarily dependent on the expertise, capability, and knowledge of fixture design engineers, and no comprehensive theoretical approach to help the entire process exists. The industrial world on the other hand, continues to seek automated fixture design systems. This research investigates the automated fixture design process utilizing the integration of design automation (DA), and multidisciplinary optimization (MDO). A high degree of automation is to be obtained by this integration, which will result in the reduction of time and expense of the manufacturing process.

The main emphasis of automated fixture design is to eliminate human intervention and increase computerised automation. The advancements in the fixture assembly include fully automated designs and optimizing the position of the assembly for a compact and collision free model (Farhan, 2013). Beside these developments in automated fixture design systems, other special issues such as developing a fixture system for different workpiece-domain still prevails. Modular fixtures contain a lot of elements which are disassembled after completion of specific jobs and reassembled for another job, making the entire process efficient and flexible (Kršulja, Barišić, & Kudlaček, 2009). Fixture design automation is based on the following characteristics:

1. Finite and predictable numbers of clamping and support locations which allows a mathematical formulation for searching these points from the master location systems.
2. Simple design of elements making its assembly and disassembly easy or even capable of robot assembly.
3. Design reliable for relative changes according to varying number of support or pickup locations.

In most cases a designer has to create a fixture assembly specific for a particular part, which can be a time consuming process. An individual tool cannot perform all operations, no fixture can hold every part. However, each work holder variation has basic similarities ensuring a simplicity in their design. In BIW manufacturing industry, the elements will be crowded which makes the assembly complicated. The fixture design verification, mainly clamping point reachability and clash detection are some of the main problems faced by planners in the early manufacturing process.

1.1. Research Questions

This paper presents a process of implementing design automation and optimization in the topic of modular fixtures for BIW manufacturing industry. The aim of this work is boiled down to three research questions:

- What criteria can be used to assess flexibility of fixture design automation?
- In what ways do these criteria aid in developing fixtures that increase the efficiency of production?
- How can multidisciplinary optimization be used to increase the flexibility of fixtures?

2. Related work and state of the art

2.1. Body in white

Body-in-white is one of the initial stages in the automobile manufacturing industry where body frames are joined together by different techniques (welding, riveting, clinching, laser brazing, and bonding). Operations done on a car body or chassis before it is taken to a paint shop is done on a weld shop and the final product is called the body-in-white (Pradeep S.A, Iye, R., Kazan H., Pillai S, 2017). BIW is intended to be rigid, restricting bending and torsional motions in all directions. According to Federal Motor Vehicle Safety Standard (Hollowell, Gabler, Stucki, Summers, & Hackney, 1998), it must provide high-quality protection to a car's body and its occupants against all types of crashes and rollover. It should also be capable of absorbing or decreasing noise, vibration, and/or harshness (NVH) to protect the passengers. Improvements in fuel economy mandate the use of lightweight materials in BIW, as it accounts for a substantial portion of the vehicle's weight; also, given recent environmental concerns, it is intended to be recyclable. Two different types of BIW structures are monocoque structures, in which all members are load carriers, and body-on-frame structures, where the frame carries most of the load.

2.2. Modular fixtures

Modular fixtures are made up of a base and extensions that are moveable and allow for quick configuration adjustments. These fixtures may be swiftly created with computer-aided fixture design software and are reusable in numerous configurations. They are also made to very precise tolerances, ensuring that the finished product is free of defects. In general, the design procedure for modular fixture devices entails the proper selection of locating, supporting, and clamping parts, as well as their accurate placement on the base plate (Mihaylov, 2019). One of the locating point layouts that can facilitate the constraining of work-piece in all 6 DOF is the 3-2-1 principle (Nee, Kumar, & Tao, 2004). In this principle, three locators are positioned in the first plane, two locators in the second plane that is perpendicular to the first, and one locator in the third plane, perpendicular to the first and second plane.

2.3. Design automation

The term design automation refers to design-related tasks in the field of mechanical engineering (Frank G, Entner D, Prante T, Khachatouri V, Schwarz M, 2014). According to M. Cederfeldt and F. Elgh (2005), design automation is "computerized automation of tasks that are related to the design process through the implementation of information and knowledge in tools or systems". The focus of research in the field of design automation has been on the automation of the design object and the automation of the design process (Elgh, 2012). The design process for a customized product is augmented by a detailed description of the specific processing activities required within the design process (Ulrich, Eppinger, 2016). This is where design automation can be introduced to repeat these activities to generate automated product variants from a pre-defined design process. Sunnersjö (1994) states that the potential for design automation increases with an increase in the maturity of the product and the customization degree of the project. However, design automation can be achieved at several levels of complexity, ranging from the use of predefined machine elements or family template systems to knowledge-intensive CAD systems or highly sophisticated knowledge-based engineering systems (Siddique & Yanjiang, 2002; Tomiyama & Hew, 1998).

Automating tedious and repetitive design tasks will free the designers to focus on the tasks that require skill, creativity, intuition, and cooperation to be solved. One of the important benefits of design automation is quality assurance as there will not be any differences in the design from different processes (Mikael, 2007). Building a framework to create CAD models with a high degree of customization allows higher freedom in the flexibility of modelling.

2.3.1. Knowledge based engineering

According to Craig & Pinfold (2001), "Knowledge-based engineering (KBE) is an engineering method that represents the merging of artificial intelligence (AI) techniques, object-oriented programming (OOP), and CAD technologies, giving benefit to customized or variant design automation solutions". Moreover, KBE is also identified as a technology capturing the product and process engineering knowledge and reusing it systematically with an aim of reduced time and cost (La Rocca, Gianfranco, 2012). The main objective of KBE is to automate repetitive tasks by the application of knowledge-based systems (KBS). One of the distinguishing features of KBS is the separation of knowledge base and functions which makes use of the knowledge called the interface engine (Tarkian, 2012). The separation of an interface engine and knowledge base allows the upgrade of design in the future without affecting the interface engine, making the maintenance of the design automation framework faster and efficient.

The separation of knowledge base with interface engine helps in achieving higher framework flexibility while increasing the maintainability of the design automation framework. The knowledge base consists of rules, relations, and facts, however, it is not stored sequentially as it is required to execute. The interface engine acts as a tool that uses this knowledge stored in the knowledge base. Forward chaining and backward chaining are the common types of interface engines, which are used to trigger the knowledge stored in the knowledge base (Tarkian, 2012). In forward chaining interference, the rules are found and executed that fulfil the given condition. Later, the rules are stated, listed down, and executed until the results are acquired. However, a backward chaining interface is a goal-oriented interface, where the interface engine searches for rules that produce the results and is passed back to the interface engine to be executed to obtain the result.

2.4. Design optimization

The topic of design optimization investigates the use of numerical optimization techniques in the design of engineering systems that could comprise of different disciplines or components. Since the inception of multidisciplinary design optimization (MDO), several techniques (architectures) have been developed and deployed to solve MDO difficulties. After establishing a well-functioning product model using design automation and KBE, optimization algorithms can be used to investigate what input values should be utilized to get the best design attributes (Wehlin, 2021). Design automation enables the use of advanced optimization by the creation and recreation of parametric CAD models

according to the design variables in the optimization run. A wide range of optimization algorithms have been created to handle design optimization problems and execute optimizations. Many real-world situations have conflicting interests, and maximizing a specific solution concerning to a single aim might result in undesirable outcomes with respect to the other purposes. A sensible approach to a multi-objective problem is to study a range of solutions, each of which achieves the objectives at a satisfactory level while not being dominated by any other option (Konak, Coit, & Smith, 2006).

2.4.1. SIMPLEX algorithm

SIMPLEX algorithm is a method to solve non-linear single objective optimization problems (Barati, 2011). The NelderMead or downhill simplex strategy is used to discover the lowest or maximum of an objective function in a multidimensional space. The SIMPLEX algorithm provided in ModeFRONTIER runs until the maximum number of evaluations or final objective accuracy (or convergence) is achieved. Simplex is capable of dealing with both continuous and discrete variables. It is more resilient than gradient-based techniques and ideal for problems involving noisy functions because it does not compute derivatives. Simplex algorithm does not use derivatives and hence the termination is based on the gradient of the objective function (i.e, when the convergence is reached and the algorithm cannot find solutions with improvements).

2.5. Robotic simulation

Production planning plays a significant role in the development of manufacturing industries. An increase in customer needs and changing demands in the products gives the manufacturing system a challenge of evolution in terms of methods or innovation in the modern manufacturing society. Flexible manufacturing and customization are integrated into the modern manufacturing society to improve the system's responsiveness to meet the market demands (Wang, Chang, Xiao, Wang, & Li, 2011). In manufacturing engineering, the digital manufacturing process provides support from designing to the marketing of the products, involving different domains like product development, Virtual manufacturing, Robot Simulation, and Ergonomics analysis, etc. The Robot Simulation environment is applied to configure the 3D simulations of different tasks and operations in manufacturing processes and analyse them to create collision-free robot paths (Caggiano & Teti, 2018). Robot simulation can be considered as a promising technology for the development of products in terms of improved time and cost reduction while increasing product quality. In robot simulation, it is required to define the structure of the plant, lines, station, resources, and product in a 3D space and relate all these together by several operations to show and verify the flow of products and resources. Today robots are utilized in industries for doing more precise operations such as welding, assembling, etc., to increase the efficiency in production.

3. Methodology

The method of creating modular fixtures and spot-welding operations on a BIW is divided into design automation, design optimization, and robotic simulation. This is a quantitative research approach through which information is collected and categorized using CAD and optimization tools like CATIA V5 and modeFRONTIER. In this approach, the Product Manufacturing Information (PMI) of the BIW model is used as input source for design automation and robot simulation.

3.1. Design Automation

Following the extensive background research, simple and modular fixture elements are designed in CATIA V5 and assembled as shown below (Figure 1). CATIA accepts Visual Basics which allows for most of the features in it. Instead of the built-in visual basic editor, automation of CATIA can be accessed through Microsoft Excel which uses VBA (Visual Basics for Applications). Once all the required libraries and application documents are loaded to the module, product documents and root products are declared in the VB script. Design automation of modular fixtures in this paper starts from the automatic creation of product files in CATIA V5 and inserting the BIW model selected by the user in the excel interface. For ease of designing, different fixture elements for gripper and pick-up units

are designed separately and assembled through automation process. Functions are introduced to the program to increase the readability of the code, reduce repetition of script and to make the update of code easier in the future.

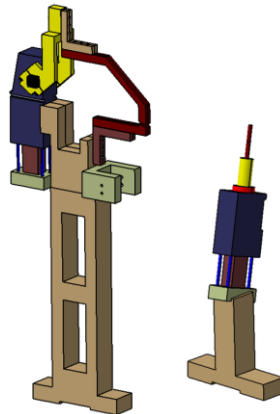

Figure 1. Gripper and pick-up unit

For a single gripper/clamping unit, five different components (Clamp, L-block, Actuator arm, Cylinder and Riser) are designed in this process. The control flow of code for gripper units in a BIW model is as shown below (Figure 2). Unlike the gripper unit, pick-ups have only two elements (pin/locators and riser). However, the same structure of code with a change in the looping argument. One major change in the code structure for the pick-up unit is the creation of a secondary axis system. Here, the secondary axis system will be of a Standard type while the primary one is Euler type. Moreover, the Z-axis of secondary axis system is aligned with the 'centre-line' of the slots/holes in BIW. There are numerous slots/holes in BIW, each having a centre-line, the automation script measures the minimum distance between the instantiation input (Master Locating System) and all the centre-line in the BIW part. When the measured distance is obtained as zero, the corresponding line is taken as a reference for Z-axis of the secondary axis system. This method makes use of forward chaining interface type as the rules and conditions are executed until the results are obtained.

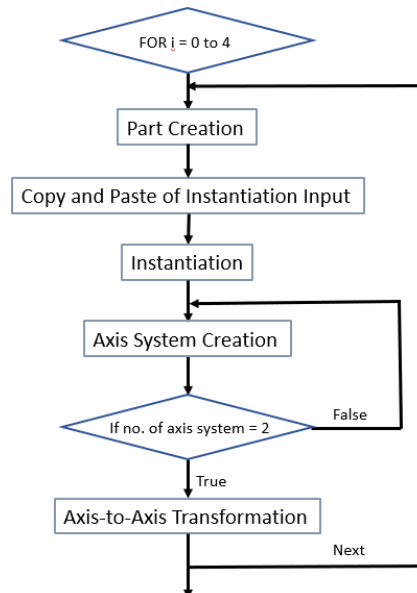

Figure 2. Control flow of design automation code for gripper unit

3.2. Robot Simulation

In an automobile industry (BIW workshop), the car body parts are called products whereas robots, weld-guns etc. are called resources and the directives of how to assemble the products using resources are called operations. With the help of Robot Simulation Automation (RSA), most of the real-time errors can be observed and estimated through robot simulation. Hence, the efficiency can be increased, and the time and cost can be decreased in the industrial manufacturing process. In this project, Robot Simulation (RS) is used to plan and design the process of spot-welding operation on the workpiece (BIW) which is held on a Modular Fixture Platform (MFP). 3D Experience in connection with Visual Studio API is used for the automation of robot spot-welding simulation. A Process, Product and Resource (PPR) Context allows the creation of a manufacturing context, which contains products, processes, manufacturing systems, and physical resources. Manufacturing layout/footprint is created within the selected area in the robot simulation module with a robot, weld-gun, MFP and fixture assembly positioned in the desired orientation. The flow chart shown below (Figure 3) is the representation of the flow of process in the automation of robot spot weld simulations. The steps in automation of robot spot-welding simulations are:

- First step in automation is the creation of robot spot trajectory by using the predefined group of spot weld positions (SWP)/locations.
- A new robot task is created to store all the robot operations and motions.
- A loop is inserted to the framework which adds all SWP (one at a time) to the previously created robot spot trajectory.
- Robot spot trajectory is attached as robot path for the welding process. The robot motion and spot welding operation for each SWP is created inside this loop.
- Before 'Teach' task operation, the singularities are checked by jogging the robot. Different configurations of kinematics and joint values of the robot is modified in the jog mechanism to avoid robot singularities.
- Finally, the robot task simulation is executed and robot spot welding process is visualized.

After finishing the automation of RS, 'robot sweep' is extracted from the created spot-weld trajectories, which will be later used for the optimization process.

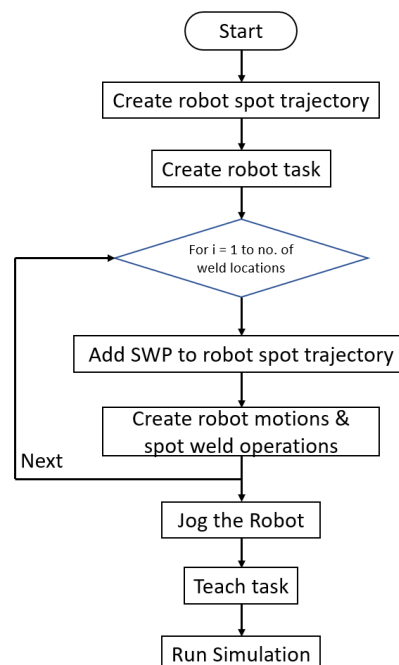

Figure 3. Control flow of automation code for robot spot welding simulation

3.3. Design optimization

Multidisciplinary design optimization (MDO) is a field in engineering which uses numerical optimization techniques to achieve a better design/system. The MDO tool used in this project is called modeFRONTIER, which is a commercial software program that offers a user-friendly environment for optimizing novel designs. The optimization is carried out with modular and profile-based access, allowing for the automation of the design simulation process as well as enhanced analytical decision-making.

3.3.1. Problem formulation

The initial step in the optimization process of a fixture design is problem formulation. To create an optimization framework the existing problem is identified and objectives are set up to eliminate this problem. After the completion of design automation and robot simulation, the main problem encountered was the clash between different elements in the assembly. Since a clash-free fixture assembly being the primary requirement, it is kept as the main objective of the optimization process.

3.3.2. Framework

After identifying the problem in the automated fixture design, the optimization framework is defined in modeFRONTIER as shown in (Figure 4). The SIMPLEX algorithm is used in the inner loop of this framework. Simplex is a non-linear optimization technique with a single target. The main function of the outer loop is to determine the total number of flags in a fixture assembly and to select a number within the range of 0 to 'Number of flags'. The selected number will be the product ID of the gripper unit in the CATIA file. This number (CATProduct) is sent into the inner loop/scheduling project as an input.

Framework shown in (Figure 4), has three inputs: one which is the product number obtained from the outer loop while others are 'Angle' and 'Clamp Length'. The range of the input 'Angle' varies from 0 to 359 with a step value of 5 and 'Clamp Length' varies from 100 to 200 with a step value of 5. All three inputs are connected to a macro-enabled excel sheet, where the macros will be executed with each iteration in the modeFRONTIER. The script performs a clash test between the product and all other components elements in the fixture assembly. The total number of clashes and intersection volume (between fixtures and dummy volume of robot sweep area) is displayed in the excel sheet as an objective. All the gripper elements are in contact with the BIW model and table/base plate. Apart from other clashes, these two are desired contact/clash. However, at some clamping locations, there are two sheet metal bodies, causing CATIA to interpret it as two clashes instead of one. Hence, the number of desired clashes will vary for different gripper units.

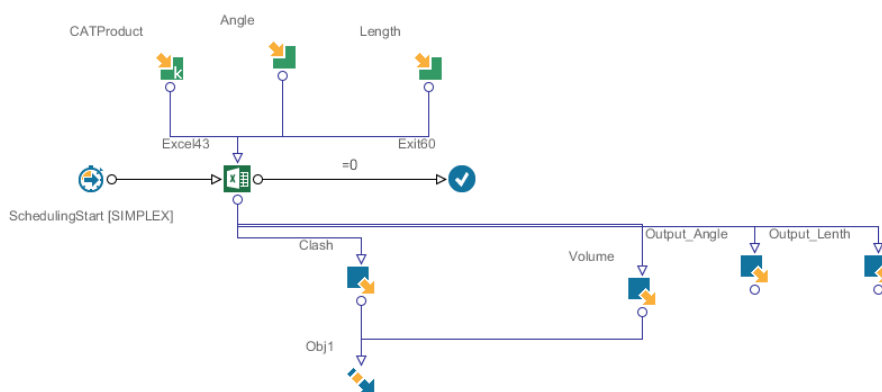

Figure 4. Optimization framework in modeFRONTIER

4. Results and discussion

Automating design enables engineering knowledge to be captured and reused. Moreover, automation simplifies downstream development processes by reducing errors and time spent on repetitive, tedious

modelling tasks. The entire framework only takes the BIW model as an input from user and automatically creates a fixture design in CATIA, and the final orientation of assembly is optimized after taking results from the automation of welding simulation. Implementation of KBE minimized the routine fixture design and planning time which allows for increased creative/innovative design time in an industry. This work helps the knowledge of design technique, clamping location, fixturing rules and automation process of a fixture design to be captured, stored and reused for different BIW models. Once the initial design phase is completed, the automation is carried out according to (Figure 2) to create the fixture assembly as shown below (Figure 5). For this BIW model, 10 gripper and pick-up units are created automatically. It can be observed that all gripper units are at 90 degrees causing undesired clashes between each other. In this paper the criteria considered for a flexible fixture design is reusability of this method, modularity of fixture elements and setup time for the entire model. These criteria ensure the reliability of this method and increase the quality of products with less setup cost which will improve the efficiency of production.

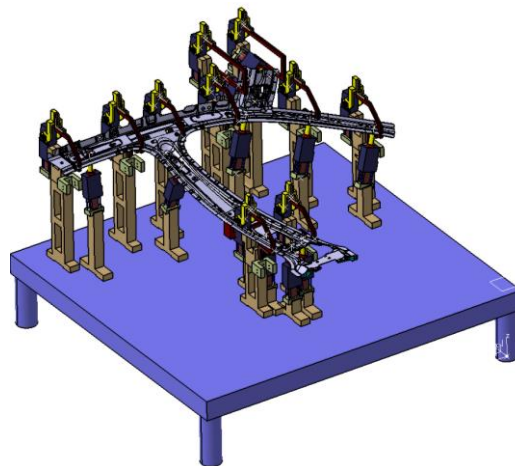

Figure 5. Design automation result - Isometric view

Programming of industrial robots is a time-consuming procedure, making its deployment difficult for small or medium-sized businesses and/or for lower batch quantities, such as prototyping. As shown in (Figure 3), robot spot trajectory is created taking spot welding positions (SWP) as references, which are provided by the R&D department of BIW model. By attaching the spot weld trajectory as a robot path for welding, the robot motions, and the spot-welding operations for every SWP is created. The robot task that is created is modified according to the user preference or requirements with the help of the 'Teach' operation. Solving all singularity issues in the simulations, robot sweep volume is traced and exported as a '.stl' file and inserted into the automated fixture design result as seen below (Figure 6).

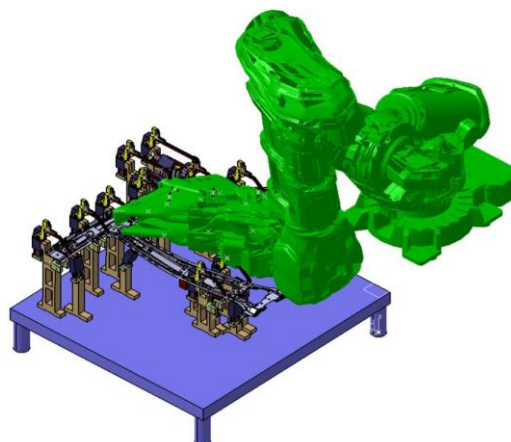

Figure 6. Robot sweep volume extracted after spot-welding simulation

Using the optimization framework shown in (Figure 4) and (Figure 5), the automatically generated design is optimized as shown below (Figure 7). As we used the SIMPLEX algorithm, the best solution to the optimization problem is among the last iterations/designs. From (Figure 8), there are numerous undesired clashes in the DA results, while the optimization results are clash-free. Due to the inability of CATIA in calculating the intersection volume with a '.stl' file, a dummy volume is used instead of the actual robot sweep volume. Restriction in the motion of pick-ups has constricted the optimization framework to neglect them while considering only gripper units in the assembly. This MDO framework reconfigures the assembly to improve the ergonomic conditions for welding process, hence increasing the flexibility of the fixtures. However, this framework can be further developed in future to include weight, size, cost, etc. which will improve the flexible fixture efficiency.

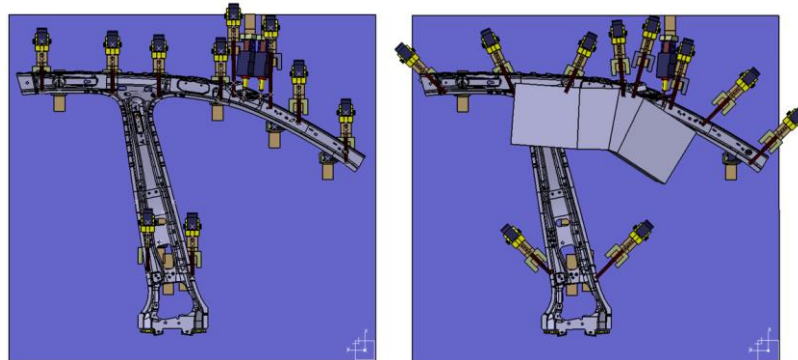

Figure 7. Comparison of design automation (left) and optimization results (right)

5. Conclusion

This paper presents a novel approach for fixture design and optimization. With design automation, repetitive tasks are eliminated by effective knowledge management and standardization. Design automation frees up time for value-creating activities, improves product and production development efficiency, and boosts firm competitiveness. In this project, parametric models are created which increases the fixture design flexibility. DA, optimization and robotic simulation processes are used to create fixtures that boost production efficiency.

This work provides a flexible framework that can automate the fixture design for BIW structure and optimize this assembly for a clash-free model. Establishing this framework makes it possible to efficiently explore the design space of new fixtures every time the BIW design is altered. This will save time and most importantly help the companies to concentrate on their primary product.

Acknowledgement

This research has been made possible by the financial support received from Vinnova-FFI AutoFix project (2020-02974)

References

- Barati, R. (2011). Parameter Estimation of Nonlinear Muskingum Models Using Nelder-Mead Simplex Algorithm. *Journal of Hydrologic Engineering*, 16(11), 946-954. [https://dx.doi.org/10.1061/\(ASCE\)HE.1943-5584.0000379](https://dx.doi.org/10.1061/(ASCE)HE.1943-5584.0000379)
- Caggiano, A., & Teti, R. (2018). Digital factory technologies for robotic automation and enhanced manufacturing cell design. (D. Pham, Ed.) *Cogent Engineering*, Vol. 5(No. 1). doi:<https://doi.org/10.1080/23311916.2018.1426676>
- Craig, B. C., & Pinfold, M. (2001). The application of knowledge based engineering approach to the rapid design and analysis of automotive structure. *Journal of Advances in Engineering Software*, Vol. 32(No. 12), 905-907. doi:[http://dx.doi.org/10.1016/S0965-9978\(01\)00041-2](http://dx.doi.org/10.1016/S0965-9978(01)00041-2)
- Elgh, F. (2012). Decision support in the quotation process of engineered-to-order products. *Advanced Engineering Informatics*, Vol. 26(No. 1), 66-79. doi:<https://doi.org/10.1016/j.aei.2011.07.001>
- Farhan, U. H. (2013). An integrated computer-aided modular fixture design system for machining semi-circular parts. Retrieved from <https://ro.ecu.edu.au/theses/555>

- Frank G, Entner D, Prante T, Khachatouri V, Schwarz M. (2014). "Towards a generic framework of engineering design automation for creating complex cad models". *International Journal on Advances in Systems and Measurements*, Vol. 7(No. 1-2), 179-192.
- Goldberg, D. E. (1989). *Genetic Algorithms in Search, Optimization and Machine Learning*. Addison-Wesley Publishing Company, Inc.
- Heidar Hashemi, Awaluddin Mohamed Shaharoun, Izman S. (2014, December). Fixture Designers Guidance: A Review of Recent Advanced Approaches. *Jordan Journal of Mechanical and Industrial Engineering*, Vol. 8, 377-384.
- Hollowell, W. T., Gabler, H. C., Stucki, S. L., Summers, S., & Hackney, J. R. (1998). *Review of Potential Test Procedures for FMVSS NO.208*. Office of Vehicle Safety Research.
- Karl T. Ulrich, Steven D. Eppinger. (2016). *Product Design and Development* (6th ed.). New York: McGraw-Hill Education.
- Karloff, H. (2009). The Simplex Algorithm. *Linear Programming*, 23-47. doi:https://doi.org/10.1007/978-0-8176-4844-2_2
- Konak, A., Coit, D. W., & Smith, A. E. (2006). Multi-objective optimization using genetic algorithms: A tutorial. *Reliability Engineering and System Safety*, 992-1007.
- Kršulja, M., Barišić, B., & Kudlaček, J. (2009). Assembly Setup for Modular Fixture Machining Process. *Advanced Engineering*.
- La Rocca, Gianfranco. (2012). "Knowledge based engineering: Between AI and CAD. Review of a language based. *Advanced Engineering Informatics*, Vol. 26, pp. 159-179. doi:<https://doi.org/10.1016/i.aei.2012.02.002>
- M. Cederfeldt, F. Elgh. (2005). Design automation in SMEs-Current state, potential, need and requirement. *International Conference on Engineering Design* (pp. 1507-1521). Melbourne: Engineers Australia. Retrieved from <https://search.informit.org/doi/10.3316/INFORMIT.390095181685561>
- Mihaylov, O. (2019). Determining the Positions of the Elements for the 3-2-1 Principle of Location in a Solidworks Add-in. *12th International Scientific and Practical Conference*, Vol. 3, pp. 160-165. Rezekne. <https://dx.doi.org/10.17770/etr2019vol3.4138>
- Mikael, C. (2007). *Planning Design Automation A structured Method and Supporting Tools*. Göteborg, Sweden: Chalmers University of Technology, Product and Production Development.
- Nee, A. Y., Kumar, A. S., & Tao, Z. J. (2004). *An Advanced Treatise on Fixture Design and Planning* (Vol. Vol. 1). Singapore: Series on Manufacturing Systems and Technology. doi:<https://doi.org/10.1142/5671>
- Poles, S. (2003). Technical Report 2003-005, The SIMPLEX Method. ESTECO .
- Pradeep S.A, Iye, R., Kazan H., Pillai S. (2017). *Automotive Applications of Plastics: Past, Present and Future* (2nd ed.). Applied Plastics Engineering Handbook. doi:<https://doi.org/10.1016/B978-0-323-39040-8.00031-6>
- Siddique, Z., & Yanjiang, Z. (2002). *Automatic Generation of Product Family Member CAD Models Supported by a Platform Using a Template Approach*. Montreal, Canada: Proceedings of DETCO2: ASME Design Engineering Technical Conferences.
- Sunnersjö, S. (1994). AID-Features: A New Tool for Design Automation. *Proceedings of CACD94: Lancaster International Workshop on Engineering Design* (pp. 241-258). Lancaster: Lancaster University Engineering Design Center.
- Tarkian, M. (2012). *Design Automation for Multidisciplinary Optimization : A High level CAD Template Approach*. Linköping: Linköping Studies in Science and Technology. Dissertations, No. 1479.
- Tomiyama, T., & Hew, K. P. (1998). Knowledge Intensive Computer Aided Design: Past, Present and Future. *Knowledge Intensive Computer Aided Design, IFIP TC5 WG5.2 Third Workshop on Knowledge Intensive CAD*, (pp. 3-18). Tokyo. doi:http://dx.doi.org/10.1007/978-0-387-35582-5_1
- Wang, J., Chang, Q., Xiao, G., Wang, N., & Li, S. (2011, September). Data driven production modeling and simulation of complex automobile general assembly plant. *Computers in History*, Vol. 62(No. 7), 765-775. doi:<https://doi.org/10.1016/j.compind.2011.05.004>
- Wehlin, C. (2021). *Optimization-Based Configurators in the Product Development Process*. Linköping: Department of Management and Engineering, Linköping University.