

# Performance of the Candidate Modulation Wave-forms for 5G Communication Systems

Samuel Acquah\*, Anastasia Krampah-Nkoom\*\*, Mark Owusu Adjei\*\*\*

\*Mechatronics & Automation Engineering Department, Shanghai University, China

\*\*School of Management and Business Administration, Jiangsu University, China

\*\*\*College of Landscape Architecture, Plant Science, Sichuan Agriculture University, China.

DOI: 10.29322/IJSRP.10.06.2020.p10274

<http://dx.doi.org/10.29322/IJSRP.10.06.2020.p10274>

**Abstract:** In surveillance of the contemporary swift growth of progressing networks, attention has been enthralled mostly on the operational properties of multifaceted networks in wireless communications. A number of mammoth simulated networks of this thoughtful have lately been fashioned, which opens an extensive field for the study of their topology, advancement, and the intricate processes which transpire in them. Fifth Generation (5G) will have to survive with a high degree of heterogeneity in relations to services and necessities. Amid these end, the malleable and well-organized use of non-contiguous unexploited spectrum for diverse network disposition scenarios is well-thought-out a key encounter for 5G, New Radio (NR) systems. Furthermore, this study weighs and equates the complexity of the different waveforms. Keen valuations on Spectral Efficiency, Power Spectral Density, Peak-to-Average Power Ratio and robustness to asynchronous multi-user uplink transmission have been explored in this study. The reimbursements of these new wave-form for the anticipated 5G uses cases are noticeably highlighted on illustrative standards and experiments. Each network will be accountable for handling user-mobility, although the terminal will make the final optimal among different wireless/mobile access network suppliers for a given service. The main impact of this study is definition of 5G mobile network perception, which is seen as user-centric notion in its place of operator-centric as in Third Generation (3G) or service-centric concept as seen for Fourth Generation (4G). The 5G terminals will have software distinct radios and modulation scheme as well as new error-control schemes can be downloaded from the Internet on the run. The growth is seen towards the user terminals as an emphasis of the 5G mobile networks. The theoretical results are further verified using Matlab evaluations for Spectral Efficiency, Power Spectral Density and Peak-to-Average ratio. The evaluation results reveal that if an apriori information on the Signal-to-Noise Ratio (SNR) is present, it is possible to highly increase the Spectral Efficiency (SE) of the transmission.

**Key words:** - 5G NR, Modulation, Physical Layer, OFDM, UFMC, FBMC, Wave-form

## I.INTRODUCTION

In modern years, fifth generation (5G) wireless networks have enticed wide-ranging research concerns. The possibility of 5G will eventually span from mobile broadband services to next-generation automobiles and associated devices. Rendering to the 3rd Generation Partnership Project (3GPP) [1], [2] 5G networks ought to back three major families of applications, including Enhanced Mobile Broad Band (eMBB) [1], [2]; massive machine type communications (mMTC) [1], [2]; and Ultra-Reliable and Low-Latency Communications (URLLC) [1], [2]. Beside this, Enhanced Vehicle-to-everything (eV2X) communications are also give thought to, as an imperative service that should be sustained by 5G networks [1]. These situations entail enormous connectivity with extraordinary throughput system, enhanced Spectral Efficiency (SE) and enforce significant contests to the design of general 5G networks. To accomplish these new necessities, new modulation and Multiple Access (MA) structures are being discovered.

In this, more prominence is positioned on the new modulation techniques for 5G networks. OFDM is extensively used in recent wireless systems and standards, many potential modulation schemes for 5G networks are carried out from OFDM for backward compatibility reasons. Hence, OFDM will be the foundation as the traditional scheme [3]. Nevertheless, UFMC and FBMC will be the other two modulation waveforms for supplementary deliberations in this study. OFDM has been implemented in fourth Generation

(4G) networks. With a proper Cyclic Prefix (CP), OFDM is able to deal with the interruption range of wireless frequencies with modest discovery methods, which makes it a common clarification for recent broadband conduction. Nevertheless, traditional OFDM is not able to meet numerous innovative demands vital for 5G networks. For example, in the mMTC scenario [1], [2], sensor nodes regularly transfer diverse types of data asynchronously in a constricted bands whereas OFDM involves diverse users to be extremely coordinated, else there will be enormous interloping amid end-to-end substitute bands. This research will concentrate on the diverse candidate wave - forms; their communication performance, advantages and inadequacies with concerns to 5G NR.

## II.EVOLUTION OF 5G

The main benefit of 5G over 4G will be its capacity to provide super-fast (on the order of 10 Gbps), unfailing and high-quality connectivity with very low latency (a few milliseconds at most) in sustenance of fresh use cases and the billions of sensors that make up the Internet of Things (IoT). Analytically, 5G networks are anticipated to feature meaningfully improved spectral proficiency and enhanced exposure.

As stated in [4–7] 5G New Radio has been defined as the first ever cellular technology to maneuver at millimeter-wave frequencies, provide GHz of bandwidths, and exploit an enormous number of antennas. NR will function in the sub-1 GHz to 100 GHz carrier frequency range under different types of dispositions to support numerous human-centric and machine-centric applications. 5G systems are the next foremost phase of mobile telecommunications principles. The space of 5G will eventually range from mobile broadband services to next-generation automobiles and linked devices. These cited school of thoughts have specified in [3] that (5G) wireless networks face countless tasks and in edict to aid large-scale varied traffic and users, consequently innovative modulations and Multiple Access (MA) systems is being developed to meet the varying demands. As stated by [8], two substantial inclinations are aiding the race to 5G, thus: the volatile growth in claim for wireless broadband that can transmit video and other content-rich services, and the IoT, where enormous numbers of smart devices communicate over the Internet. Although [9] defined 5G as wireless connectivity for what so ever that can benefit from being connected. To assist a surely networked society, as cited in [10] there are three major encounters:

- An enormous progress in the number of associated devices.
- An immense growth in traffic volume.
- An extensive range of applications with different requests and features.

The key is to study on the designing of different waveforms, different communication performance on them, and advantage and shortcomings on them [5]. To be able to accomplish these goals, 5G will provide exciting broadband speed, ultralow latency, and ultrareliable web connectivity support. [11] Emphases on the physical (PHY) layer, and in exact on the attained modulation schemes, the evolution has been from binary modulations such as the Gaussian Minimum Shift Keying (GMSK), used in the Second Generation (2G) Global System for Mobile (GSM) system, to QAM schemes with adaptively chosen cardinality, presently used in 4G systems. [12] In this research the objective is to ostentatious on the candidate waveforms: OFDM, UFMC and FBMC to associate and compare the communication channels, enactment, facts and inadequacies among them.

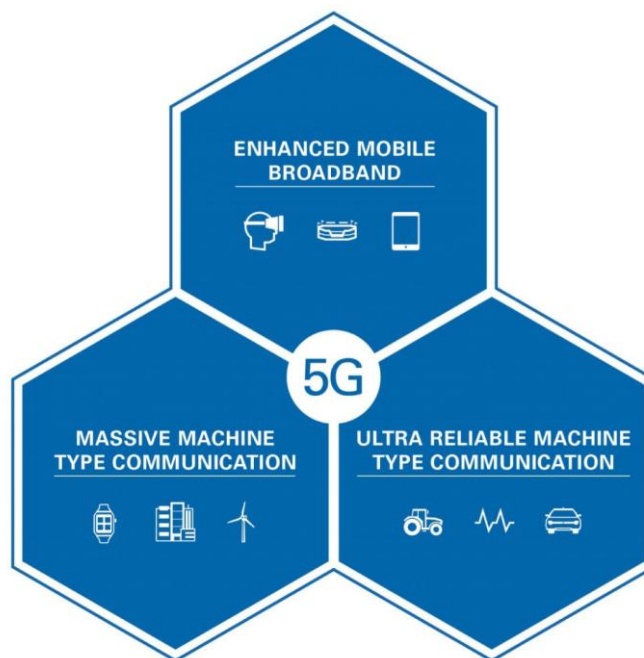
## III. EXPECTED 5G APPLICATIONS

To administer higher bandwidth capacity than current 4G–supporting broadband, 5G will allow a higher density of mobile broadband users and sustain ultrareliable device-to-device and massive machine-type communications. These higher bandwidth capacities are:

- eMBB - Enhanced Mobile Broadband. For high-capacity and ultrafast mobile communications for phones and infrastructure,

simulated and improved authenticity, 3D and ultra-HD video, and haptic feedback

- URLLC - Ultrareliable and Low Latency. For vehicle-to-vehicle (V2V) and Vehicle-to-Infrastructure (V2I) communications, autonomous driving
- mMTC - Massive Machine -Type Communications. For consumer and industrial IoT, Industry 4.0 mission-critical Machine-to-Machine (MC-M2M). To meet these expanding connectivity requirements, 5G is being designed to meet the new Information Management Technology (IMT)-2020 performance targets that are being defined by the International Telecommunication Union (ITU) based on the target 5G service areas. It spells out new requirement dimensions such as ultra-high reliability (e.g., 10<sup>-5</sup>/1ms) as well as improvements over IMT-Advanced that defined requirements met by Long Term Evolution (LTE) Advanced Release 10. 5G will differentiate itself by delivering the improvements such as:
  - 10x experienced throughput – bringing more uniform, multi-Gbps peak rates
  - 10x decrease in latency – delivering latency as low as 1 ms
  - 10x connection density – enabling more efficient signaling for IoT connectivity
  - 3x spectrum efficiency – achieving even more bits per Hz with advanced antenna techniques
  - 100x traffic capacity – driving network hyper-densification with more small cells everywhere
  - 100x network efficiency – optimizing network energy consumption with more efficient processing



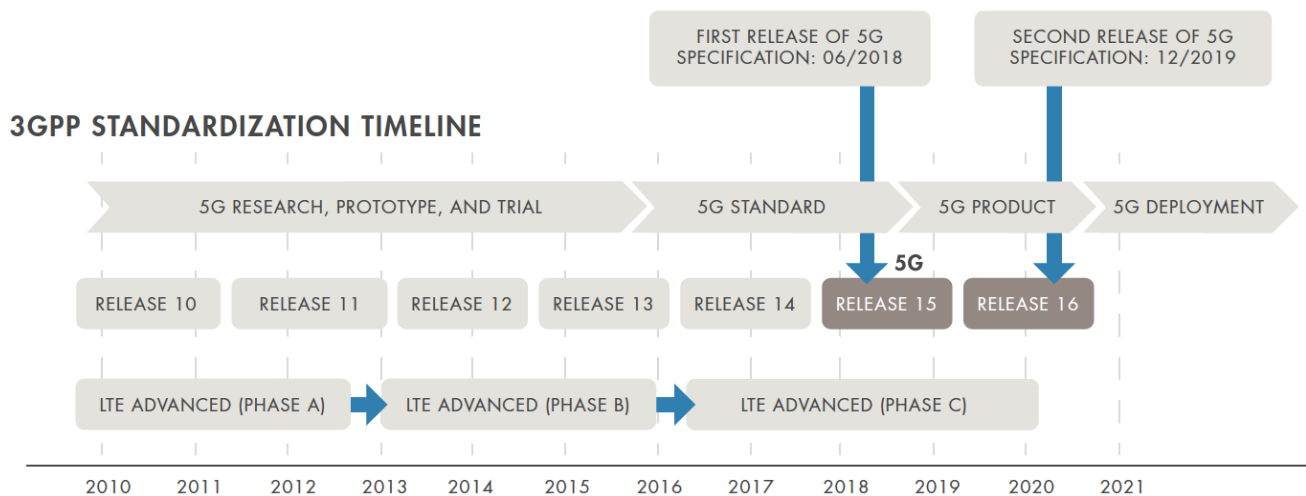
**Figure 1:** Expected 5G Application: Enhanced Mobile broadband, ultrareliable device-to-device and massive machine-type communications.

**Table 1:** 5G key parameters

Key 5G Parameters	
Latency in the air link	< 1 ms
Latency end-to-end (device to core)	< 10 ms
Connection density	100x vs current 4G LTE
Area Capacity density	1 (Tbits/s) /km <sup>2</sup>
System spectral efficiency	1 (Tbits/s) /km <sup>2</sup>
Peak throughput (downlink) per connection	10 Gbit/s
Energy efficiency	> 90% improvement over LTE

**IV. 5G STANDARD TIMELINE**

According to [1], [13]–[19]. The 3rd Generation Partnership Project (3GPP) standardization group defines the wireless 5G standard, with assistance from many partakers and contributors around the globe. Publication of the 15 of the 3GPP standard, concluded in June 2018, announces the 5G standard. Physical layer algorithms, millimeter wave technology, and considerable MIMO architectures are likely to be meaningfully diverse from 4G LTE technologies. Contemporary 5G advancement centers on enabling technologies such as elastic baseband and RF technologies, hybrid beamforming, and enormous MIMO systems; rapid prototyping and field trials; and authentication of conformity with the recent systematic stipulations.



**Figure 2.** 3GPP Standardization timeline

## V. 5G PHYSICAL LAYER

According to [10] like for any wireless technology, the physical layer forms the mainstay of 5G NR. The NR physical layer has to back an extensive variety of frequencies (from sub-1 GHz to 100 GHz) and numerous disposition possibilities (pico cells, micro cells, macro cells). There are human-centric and machine-centric use cases with exciting and sometimes conflicting necessities. There may also be unanticipated applications with new necessities in the forthcoming. [20] With the physical layer as the backbone, the OFDM modulation setup, alongside its multiple-access approach OFDMA, is being well-thought-out as significant component, and numerous options encouraging higher values of spectral efficiency are being deliberated in current technologies. To effectively discourse such matters, 3GPP is mounting a flexible physical layer for NR. The flexible mechanisms can be appropriately enhanced with a precise thoughtfulness of radio wave propagation and hardware inadequacies in networks and devices. This is a task, because these features are less known as cited in [8]. 5G NR is the first ever mobile radio access technology going into millimeter-wave frequency range (with frequencies as high as 100 GHz), steering channel bandwidths in the GHz range, and permitting immense multi antenna systems.

## VI. 5G MODULATION

In [12] it is revealed that, the recent 4G standard, the LTE system, is centered with the application of the OFDM modulation for the downlink and of the Single-Carrier Frequency Division Multiple Access (SC-FDMA) approach for the uplink. OFDM is an orthogonal mass broadcast structure which, in perfect circumstances, cannot be afflicted by inter-carrier intrusion and Inter-Symbol Interference (ISI). Fifth generation (5G) wireless networks experience numerous encounters in order to aid large-scale assorted traffic and consumers, hence new modulation and Multiple Access (MA) schemes are being established to meet the varying request [3]

The synergy with an enormous Multiple-Input, Multiple-Output (MIMO) system is also deliberated by employing factual channel measurements. OFDM and OFDMA are the modulation techniques and the multiple access policy approved in LTE fourth-generation (4G) cellular network principles, correspondingly. OFDM and OFDMA inherited Code Division Multiple Access (CDMA), engaged in third-generation(3G) networks for numerous motives, such as the affluence of application of both transmitter and receiver thanks to the use of Fast Fourier Transform (FFT) and Inverse FFT (IFFT) blocks; the capability to stabilize multipath alteration, the orthogonality of subcarriers which eradicates inter cell interference; the likelihood of familiarizing the transmitted power and the modulation cardinality; and the comfort of incorporation with multi antenna hardware, both at the transmitter and receiver [31],[37].

In this work,[21] a fair observation of several 5G waveform candidates (OFDM, UFMC and FBMC) is projected under a common framework. PSD, SE, PAPR and robustness to asynchronous multi-user UL transmission are assessed. The following candidate waveforms are being studied on their performance, advantages and shortcomings with regards to 5G modulation:

- OFDM
- UFMC
- FBMC

Anyhow, the furthestmost obvious method used for the modulation of Multi-carrier is OFDM that is extraordinarily to time frequency misalignments because of its extraordinary comparatively side-lobe spectral level. [22] Filter Bank Based Multi-Carrier (FBMC) is assumed to be a forthcoming 5G contender revolution to usurping OFDM. Each sub-carrier can be wholly filtered in FBMC to improve heartiness against Inter-Carrier Interference (ICI) impressions. Nonetheless, anticipated FBMC frameworks use filters, whose length is varied in times of tests per multi-carrier image.

Conferring to [23] (OFDM) has been accepted as the broadcast waveform in the state-of-the-art wireless communication standards, comprising 3GPP LTE and IEEE 802.11 standard families. It is also used as a multiple access transmission technique, called OFDMA. Notwithstanding its benefits such as healthiness in contradiction of multi-path fading and affluence of enactment, OFDM suffers from a number of hitches, comprising high Peak-to-Average Power Ratio (PAPR) and high side lobes in frequency. Whereas the previous one has been allayed in LTE using Distinct Fourier Transform-spread OFDMA (DFTS-OFDMA) in the uplink, a.k.a. Single-Carrier FDMA (SCFDMA), the latter is still deliberated as a drawback.

In [24] matching three candidates' multicarrier waveforms for the air interface of 5G: filtered CPOFDM the choice for 4G, FBMC – heavily discoursed in current years, and (UFMC) a new competitor making its presence lately. We evaluate their time occurrence competence when conveying very small bursts (e.g. for machine to machine communications) and under very close-fitting response to time requirements (e.g. for car-to-car communications). While FBMC is very effective when conveying lengthy sequences, it suffers when having to convey short bursts frames. Due to the cyclic prefix and wide frequency guards, OFDM is rather unproductive. UFMC proofs to be the finest choice, here, outdoing OFDM by about 10% in any instance and FBMC in the event of very short packets whereas carrying out related for long sequences.

## VII. MULTIPLE ANTENNAS FOR 5G

Alternative technology which is being reflected is the use of a large array of antenna elements, numerous remits more than the ones in use today, to deliver variety and recompense for path loss [25]. Also known as massive (MIMO), it also permits for high resolution beamforming and is specifically beneficial at higher frequencies where antenna elements can be contracted, as mentioned in [26]. Multi antenna techniques were very imperative previously in LTE, but in NR they have an extra fundamental part to play in the system design. The delay of the spectrum for mobile communication to contain also the millimeter-wave bands have led to a beam-centric design of NR in demand to sustain analog beam-forming for attaining adequate exposure. Moreover, [27] elaborates multi antenna techniques as decisive for gratifying the routine necessities for 5G also for the traditional cellular frequency bands.

For small frequencies, multi antenna techniques are mostly augmentations of structures established in the later publications of LTE. The resolution with these developments is an enhanced spectral effectiveness driven by the ever-increasing expedition for higher data rates and aptitude in an overfilled spectrum. Advances in a vigorous array antenna technology have made it conceivable to have digital resistor over a large number of antenna elements, occasionally denoted as an enormous MIMO. This permits higher spatial determination in the multi antenna dispensation which can give higher spectral proficiencies. To this end, NR offers better support for Multi-User MIMO (MU-MIMO) and reciprocity-based operation. A new agenda for obtaining Channel State Information (CSI) has been established to permit for more elasticity in the transmission of allusion signals and to empower CSI with higher spatial resolution. This context also offers a leaner system design and makes it easier to familiarize to a varied use cases and to present new structures in future publications of NR. Centered on a corresponding frequency sphere methodology, we publish a systematic closed-form terminologies symbolizing the Physical Layer (PHY) of FBMC/OQAM- and OFDM based MIMO architectures in terms of the Signal-to Interference-plus-Noise Ratio (SINR) experienced at the output of the indicator when bearing in mind the broadcast on channels showing strong frequency discernment by [28].

For high frequencies, procuring coverage is the main task relatively than obtaining high spectral effectiveness. The motive for this is that transmission losses, when using legacy transmission techniques, are noticeably higher, though there is a huge quantity of bandwidth accessible in the millimeter-wave spectrum. To overcome higher transmission losses and deliver satisfactory coverage, beam-forming is useful, particularly under LoS circumstances and maybe both at the gNB and UE. With recent hardware technology, analog beam-forming is predictable to be dominant at millimeter-wave frequencies. Consequently, measures for

assisting analog beam-forming in both the gNB and the UE have been established in NR. Unlike preceding groups of mobile communication systems, NR assist beam-forming not only for the data transmission but also for preliminary contact and broadcast indications.[10]

### VIII. CHANNEL CODING FOR 5G

There has been some argument in the progress of the 3GPP TR 38.900 Discharge 14 channel model for above 6 GHz. For instance, once it comes to demonstrating the large-scale path loss over a space across a massive range of mm Wave frequencies, one group of researchers have wanted to unite the path loss models above and below 6 GHz, using a great collections of dimensions and depending on physics to show the path loss as a very modest one-parameter model centered on Friis' equation in the interior of the first meter of propagation for both Line-Of-Sight (LOS) and Non-LOS (NLOS) circumstances. This method is specified as the uncompelled path loss model in 3GPP TR 38.900 Release 14, yet some industry players have used a more cumbersome, sub 6-GHz legacy-based path loss model to attempt to explain proliferation from 6 to 100 GHz. [7], [20]

This method not only dearth a physical foundation with little to no better model exactness notwithstanding more constraints, but creates a incoherence at 6 GHz between sub-6 GHz consistent models, and newer models above 6 GHz. Although the physics-based single-parameter model in easily accommodates the 6 GHz boundary with no incoherence from 500 MHz to 100 GHz, the 3GPP model needs three parameters and upshots in non-physics-based model parameters in numerous circumstances. The ITU working group 5D is now bearing in mind both of these models. Some have believed that modeling the attenuation of buildings over the wide range of mm Wave frequencies might be clarified by a physics-based model that articulates attenuation as increasing with the square of frequency (parabolic), as found by Appleton for describing the refractive index of the ionosphere with frequency. [3], [4], A very modest hitherto precise model for Outdoor-to-Indoor (O2I) Building Penetration Loss (BPL) for high-loss and low-loss buildings that contemplates the quadratic increase in frequency is given by:

$$BPL_{NYU}[\text{dB}] = 10 \log_{10}(A + B \cdot f_c^2) \tag{1}$$

Where  $f_c$  is in GHz,  $A = 5$ , and  $B = 0.03$  for low-loss buildings, and  $A = 10$  and  $B = 5$  for high-loss buildings.

Nonetheless, industry contributors in 3GPP have a commonplace noticeably more intricate BPL models with very equivalent accuracy, as given by:

$$BPL_{3GPP}[\text{dB}] = PL_{npi} - 10 \log_{10} \sum_{i=1}^N (p_i \times 10^{\frac{L_{material_i}}{-10}}) \tag{2}$$

Where  $PL_{npi}$  is set to 5 dB as an extra cost added to the exterior wall loss due to numerous materials (which are detailed in [1.1]) to explain for non-perpendicular incidence in the 3GPP TR 38.900 Release 14 channel model.  $L_{material_i}$  is the infiltration loss of material  $i$ ,  $p_i$  is the proportion of the  $i$ -th material, where  $\sum p_i = 1$ , and  $N$  is the number of materials. These parameters as deliberated in [29] specifies equivalent models for 5G NR.

## IX. SIGNIFICANCE OF 5G NR

If 4G already supports decent mobile broadband, is there really a need for 5G? The answer is definitely yes as a positive response, and this is due to enormous reasons. When 4G was formed, mobile broadband was the main driver. For 5G, mobile broadband is still a significant driver, but with more light thrown to reliability, latency, throughput, data volume and mobility. 5G will need to be a paradigm modification that comprises very high carrier frequencies with enormous bandwidths, exciting base station and device concentrations and extraordinary numbers of antennas. There has been a massive improvement in mobile wireless communication since the last few decades. Bestowing to these school of taught, [9], [30] This invention entails of a number of generations which is still on-going. The passage of mobile wireless communication began with 1G trailed by 2G, 3G, 4G, and under research forthcoming generations 5G. The US Federal Communications Commission (FCC) in 1946 agreed a first mobile telephony service to be functioned by AT&T in 1947.

Due to the bulkiness, weight and extreme power consumption of the equipment at that time, it had to be fitted in a vehicle. More than three spans of cellular communication technology fruition has led to a swing from analog to digital formats of communication, moving from what was mostly voice to high-speed data communication from this opinion. In the last few years, Mobile Wireless Communication networks have experienced an extraordinary revolution. This paper [31] defines technologies that could lead to both architectural and constituent disorderly design changes: device-centric architectures, millimeter wave, an immense MIMO, smarter devices, and native assistance for machine-to-machine communications. The mobile wireless Generation (G) usually refers to a variation in the nature of the system, speed, technology, frequency, data capacity, latency etc. Every group has some values, diverse dimensions, new techniques and new structures which distinguishes it from the preceding one. The First Generation (1G) mobile wireless communication network was analog and used for voice calls only.

The First Generation (1G) of cellular communication, which mostly carried voice, nurtured up using setups such as Advanced Mobile Phone System (AMPS) in the USA and Nordic Mobile Telephone (NMT) in Scandinavia. These analog setups were later interchanged stirring near 2G with the first digital communication systems around the mid to late-1990s Global System for Mobile communications (GSM) in Europe and digital-AMPS for the USA. At this point, the Short Message Service (SMS) was made known, being one of the first extensively used non-voice applications. Development for 2.5G using improved data rates for GSM development (EDGE), General Packet Radio Service (GPRS) and Code Division Multiple Access (CDMA) glimmered the use of mobile data communication and initial cellular internet connectivity in the early-2000s. [7] The Second Generation (2G) is a digital technology and supports text messaging. The Third Generation (3G) mobile technology provided higher data transmission rate, amplified capacity and offer multimedia support and 3G is based on GSM and was propelled in 2000. The purpose of this technology was to offer high speed data. The original technology was enhanced to permit data up to 14 Mbps and more using packet switching. It uses Wide Band Wireless Network with which clearness is increased. It also offers data services, access to television/video, new services like Global Roaming. It controls a range of 2100MHz and has a bandwidth of 15-20MHz used for High-speed internet service and video chatting.

The Fourth Generation (4G) assimilates 3G with permanent internet to support wireless mobile internet, which is fruition to mobile technology and it overpowers the restrictions of 3G. It also intensifies the bandwidth and decreases the cost of possessions. 4G offers a downloading speed of 100Mbps. 4G provides same article as 3G and extra services like Multi-Media Newspapers, to watch T.V programs with more transparency and send Data much quicker than preceding generations. LTE (Long Term Evolution) is carefully as 4G technology. 4G is being established to provide somewhere to stay the QoS and rate requirements set by approaching applications



like wireless broadband access, Multimedia Messaging Service (MMS), video chat, mobile TV, HDTV content, Digital Video Broadcasting (DVB), minimal services like voice and data, and other services that exploit bandwidth transitioning. 4G LTE was familiarized, which does not only suggest major changes on the air boundary, but was moving from code division multiplexing to OFDM and Time Division Duplex (TDD) or Frequency Division Duplex (FDD). [32] LTE-A prevailed as the leading cellular access technology today and has aided as the foundation of the transition to 5G mobile communications. 5G stands for 5th Generation Mobile technology and is going to be a new rebellion in mobile market which has transformed the means to use cell phones which contains a very high bandwidth. The evolution from 4G to 5G is stirred by new human-centric and machine-centric services across numerous industries. 5G refers to Fifth Generation which was took place from late 2010s. Services that have the potency to be seen with 5G technology consist of far better levels of connectivity and exposure.

The main emphasis of 5G will be on World-Wireless World Wide Web (WWWW). It is a comprehensive wireless communication with no boundaries at all. [8] Defines 5G wireless systems as the next key chapter of mobile telecommunications criterions. The possibility of 5G will eventually range from mobile broadband services to next-generation automobiles and connected devices. The present 5G New Radio (NR) description was finalized in June 2018 and circulated in the 3GPP Release 15 specification. Now, a diversity of industry performers, comprising of network equipment vendors, network operators, semiconductor vendors, and device manufacturers, are mounting new products that contrivance the new customs. In precise, conferring to the cataloguing in [33] the main locus scenarios presently intended for 5G networks are as are termed 5G drivers.

## X. 5G DRIVERS

- A very enormous data-rate wireless connectivity. Users will be able to download large amounts of data in a short possible interval; a typical application corresponding to this scheme is high-definition video streaming, which of obviously entails a modulation scheme with large spectral volume and energy efficiency.

- IoT. Equal to one trillion devices are likely to be connected through the 5G network, permitting consumers to remotely manage things for example cars, washing machines, air conditioners, lights, and so on. Similarly, energy, water and gas delivery firms will take lead of associated smart meters so that they can regulate their networks. These connected things will have quite limited handling competences and will have to transmit small amounts of data intermittently, thus requiring a modulation scheme robust to time synchronization errors and carrying out well for short communications.

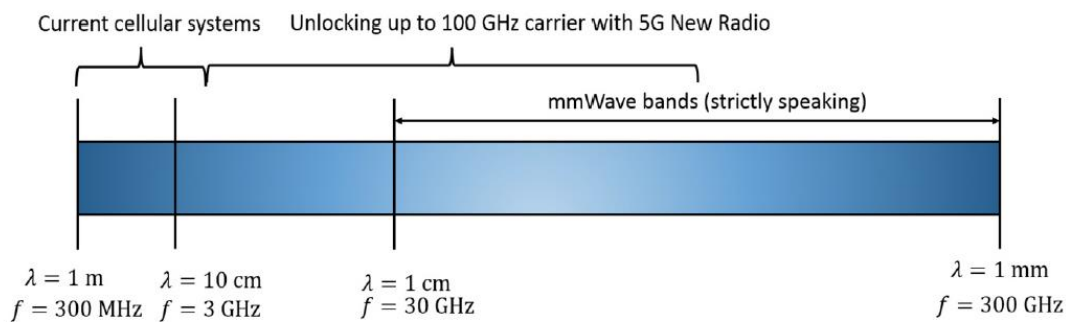
- Tactile Internet. This situation denotes real-time cyber-physical tactile control experiments (for example, remote regulation of drones and /or of rescue robots in emergency circumstances), and requires a communication service that must be consistent and reliable and have small latency. The target latency is in the order of 1ms, more than one order of magnitude lesser than the latency of current 4G systems. In order to attain such a determined target, the PHY latency of future 5G networks must not surpass 200-300. Other applications, such as on-line gaming and car-to-car and car-to-infrastructure communications, though not openly linked related to the notion of the tactile Internet, also can take chances of the low latency requirements.[27–29].

- Wireless Regional Area Networks (WRAN). It is expected that the substantial throughput of 5G networks will also fit to bringing internet broadband access to sparsely populous regions that are not yet covered by wired technologies such as ADSL and optical fiber. In this situation, network devices will have a minimal mobility, so Doppler effects will be insignificant, and also latency will not be a key prerequisite. In order to be able to meet the throughput demands of bandwidth-hungry domestic users, the use of so-called “white spaces” .In other words frequency bands licensed to other services but really not used appears inevitable. It is thus assumed that the accessible frequency bands will not be contiguous, and cognitive-like unscrupulous spectrum access is a feasible

possibility. Millimeter wave frequencies (larger than 20 GHz) also will be used. The modulation format of future 5G systems should thus be able to proficiently exploit the accessible fragmented and heterogeneous spectrum.

5G wireless access is envisioned to enable a networked society, where information can be accessed and shared anywhere and anytime, by anyone and anything [36]. 5G shall provide wireless connectivity for anything that can benefit from being connected. To permit a truly networked society, there are three main encounters as follows:

- A massive growth in the number of connected devices.
- A massive growth in traffic volume.
- A wide range of applications with diverse requirements and characteristics. To tackle these challenges, 5G wireless access not only requires new functionalities but also substantially more spectrum and wider frequency bands.



**Figure 3:** Frequency ranges of current and future mobile communication systems.

This figure demonstrates the operational frequency ranges of existing (2G, 3G, 4G) and future (5G) mobile communication systems. The recent cellular systems operate below 6 GHz. A huge amount of spectrum is available in the millimeter-wave frequency band (30–300 GHz); nevertheless, there is no commercial mobile communication system operating in the millimeter-wave frequencies today. 4G LTE is designed only for frequencies below 6 GHz. There are some local area networks and (mostly) indoor communication systems based on the IEEE 802.11ad and 802.15.3c standards that operate in the unlicensed 60 GHz band. IEEE 802.11ay, a follow-up of 802.11ad, is under development. 3GPP is presently developing a global standard for new radio access technology, 5G new radio (NR), which will work in frequencies from below 1 GHz up to 100 GHz. 5G NR will unleash current frequencies and new functionalities to back the ever-growing human-centric and machine-centric applications as quoted in [10].

## XI. PURPOSE OF THE STUDY

Inside the 5G research, one of the questions that is still uncertain about the implementation of the Radio Access Technology is the radio waveform candidates. Given these circumstances, the main objective of this research is to carry out a study of the different modulation wave-forms for 5G New Radio that can be implemented in the physical layer. We consider and evaluate, among other waveform candidates, OFDM, FBMC and UFMC. By this thesis it is expected to determine the advantages and disadvantages of each waveform model regarding the complexity, performance and spectral containment. The project consist of two different phases:

- Simulation phase. In this stage we carry out the design and simulation of the waveform candidates using a software tool called MATLAB. The models will be analyzed from several perspectives (e.g. Power Spectral Density (PSD), Peak to Average Power Ratio (PAPR), Spectral Efficiency (SE) in order to include most of the parameters with a relevant role in the decision of the radio waveform for the upcoming technology.
- Comparison over real scenario. The second phase consists of intense analysis and testing of the candidates over the given specifications. Given the compatibility between this transceiver and the MATLAB tool as a hardware controller, the schemes

designed in the previous phase are fully portable for this purpose. The results of this proof will give a solid ground to the conclusions about the advantages and disadvantages of the waveforms evaluated.

## XII. STRUCTURE OF THE STUDY

In order to understand the vivid processes followed in this study, it is kept a certain parallelism between the structure of the report and the different phases we went through for the elaboration of the project. The report is structured in 5 main chapters.

**Chapter 1: Introduction.** This presents a brief overview about the evolution of mobile communication and particularly in the upcoming fifth generation carried. Besides, it includes a project definition establishing the goals for the thesis.

**Chapter 2: Waveform Models.** In this chapter evident literature and related works are discussed to justify which types of 5G waveform performs greatly given the performance specifications. Later, each modulation scheme is theoretically described to provide a solid background.

**Chapter 3: Simulation** The third section is centered in the simulation phase. First of all, we explain the main characteristics of the simulation tool. Afterwards, a description of each scheme implemented is carried out. Finally, we present the results obtained and we compare them with the theoretical results expected.

**Chapter 4: Results and Discussion.** This chapter is focused on the analysis and vivid discussions of the simulated result over a real scenario. In this section is a well carry detailed exposition of the results gathered. Moreover, the outcomes for each waveform will be compared and discussed.

**Chapter 5: Conclusion and Future works.** The last chapter is dedicated to the conclusions drawn over the whole elaboration process of the thesis with further thoughts of future inventions.

## XIII. CHAPTER TWO – RELATED LITERATURE

## XIV. MASSIVE MIMO (MULTIPLE-INPUT-MULTIPLE-OUTPUT)

The term MIMO is used to create a system where numerous transmitters or multiple receivers are present in a system. Virtually, the system can take countless varied forms like: single input-multiple-output (SIMO) or multiple-input-single-output (MISO) system. According to [37] an audio podcast from IEEE on future network . ‘Enabling 5G and beyond’, David Soldani described that Massive MIMO (mMIMO) will be an central part of 5G from day one, including common and control channels with beam forming and tracking. With mMIMO the number of transmitting antenna elements is eventually greater than the number of MIMO streams (or layers). In reality, mMIMO means that the number of administrable antenna elements is more than eight. 5G radio will support 8 Layers Single User (SU)-MIMO or 16 Layers Multi User (MU)-MIMO in the downlink, and 4 Layers SU-MIMO in the uplink, with the likelihood of dynamic switching in both directions. Multiuser MIMO shows that parallel MIMO data streams (or layers) are transmitted to unique users at the same time-frequency resources. A typical example of 16 Layers configuration is 2layer/UE×8UE MU-MIMO.[13], [17]. Beamforming gives the merits that the same resources can be reused for multiple users in a cell: It allows Space Division Multiple Access (SDMA), greatly increasing the number of supported users within that sector: It reduces interference and increases cell capacity. As a result, Massive MIMO and Active Antenna Technologies (AAT) permits higher spectral efficiency

and administer much more capacity on existing base station sites. The technology can also improve link performance and increase the coverage area.

5G radio design is fully optimized for massive MIMO using three basic techniques for forming and steering beams:

- Digital beamforming, where each antenna element has a transceiver unit with the adaptive Tx/Rx weights in the baseband, allowing frequency selective beamforming. Digital beamforming boosts volume and flexibility and it is mostly appropriate to bands below 6 GHz.
- Analog Beamforming implements only one transceiver unit and one RF beam per polarization. Adaptive Tx/Rx weighting on the RF is used to form a beam. This is best placed for coverage at higher mm Wave bands and offers less cost and complexity.
- Hybrid beamforming is a combination of analog and digital beamforming. When some beamforming is in the analog domain, the number of transceivers is eventually much lower than the number of physical antennas, which can simplify implementation, particularly at high frequency bands. [18], [38]. This technique is suited to bands above 6 GHz. Additional [37] advantages will pop up with the introduction of the 5G core, which backs many recent enabling network technologies. For example, the 5GC is defined by a layered and service-oriented architecture, with regulate plane and user plane split and shared data layer, for subscription, state and policy information. It also supports: User plane session continuity, while the terminal migrates across different access points; interworking with untrusted access; an all-inclusive policy framework for access traffic steering, switching and splitting; and wireless-wireline convergence.

Other fundamental 5G enabling technologies, end-to-end, are: Flow-based QoS, with a much higher level of granularity than LTE, which is currently limited to the bearer service concept; multi-connectivity, where the 5G device can be connected simultaneously to 5G, LTE and Wi-Fi, offering a higher user data rate and a more reliable connection; terminal assisted Network Slicing, and end-to-end (E2E) network management and orchestration, with in-built support for cloud implementation and edge computing.

5G Network Slicing comes along with new information and role models, and slice management functions, responsible for the management and orchestration of network slice instances (NSI). An NSI consists of one or more network slice subnet instances (NSSI) of Physical Network Functions (PNF) and/or virtualized network functions (VNF).

Within this framework, three main role models are defined, namely:

- The Communication Service Customer (consumer, enterprise, vertical, CSP, etc.), who may use communication services from a Communication Service Provider (CSP);
- the Communication Service Provider builds its offering on top of network services, from the Network Operator, and virtual infrastructure services, from the Virtual Infrastructure and Data Center Service Providers; and
- The physical and virtual network functions composing the network slice instances, end to end, may be provided by Network Equipment Vendors (including VNF), Network Function Virtualization Infrastructure Suppliers, and Hardware Suppliers.

It is certain that an organizational body or entities may ensure one or several roles in this regard.

The new CSP offering, enabled by 5G Slicing, is Network Slice as a Service (NSaaS). Like cloud computing SaaS, IaaS and PaaS models, the Communication Service Customer, thus; the tenant, may compose, order and pay one or more network slice instances based on its utilization; Service Level Agreements (SLA), e.g. in terms of latency, throughput, and reliability; and value-added services (VAS). Fundamentally, 5G will support three basic business models for network slicing, depending on the tenant's degree of slice control, which may go from monitoring only the KPIs related to the signed SLAs, changing the configuration of the deployed slice instances, to chaining own physical/virtual network functions. The partitioning model may be joined with the layering model to enact joint horizontal and vertical offerings. In slice partitioning, the orchestration of resources and capabilities, from an E2E service

requirement perspective, must be horizontally federated (cooperation/collaboration), and vertically coordinated (hierarchy) through policies and standardized Interfaces /APIs. The E2E 5G systems will comprise of six domains, from terminal (UE) to the Data Network (DN) and service applications:

1. Terminals: supporting Network Slice Selection Assistance Information, to request specific slice instances, based on the communication services in use.
2. Access: eLTE/NR Radio Units with Ethernet front-haul (eCPRI) or Ethernet mid-haul for low latency and latency insensitive services, respectively.
3. Aggregation: Radio Clouds with their own Software Defined Network Controllers (SDN-C) and Virtual Infrastructure Managers (VIM).
4. Mobile core: Core Cloud with own SDN-C and VIM interconnected to the Radio Clouds by IP routers and WAN SDN-C.
5. Network Slice Management and Orchestration: An E2E Service Orchestrator for the embedding of Network Service Descriptors (Network Connectivity topology and VNF forwarding graphs), on top of a Self-Organizing Network (SON) and VNF Manager Functions.
6. Data Layer and Application Enablement: g. IoT and Customer Experience Management (CEM) platforms for running applications on top of the different network slices for public safety, digital health, mobility, industry automation, smart cities, etc.

Artificial Intelligence, in terms of descriptive, predictive and prescriptive analytics, will find application in three main domains:

- SON: Key capabilities / algorithms / architecture attributes within the different domains (RAN, Core, Transport etc.) to enable the right flexibility and tradeoffs for operators to efficiently exploit slicing;
- Data and application layers, i.e. big data analytics (structured data analytics, text analytics, web analytics, multimedia analytics, network analytics, mobile analytics), and
- Data-layer platforms for IoT and CEM.

To recognize the 5G vision presented: spectrum must be made available first, global standards, next, and regulations must follow. It is also necessary for a massive investment from industry, especially from Connectivity Service Providers (Operators) [37].

## **xv. 5G NR UNIFIED AIR INTERFACE**

At the heart of 5G is a new, more capable, unified air interface - 5G NR. It will not only significantly enhance mobile broadband, but will also enable new services such as mission-critical control and massive IoT. [39] 5G NR adopts an optimized OFDM-based family of waveforms and multiple access, as well as a common, flexible framework that enables efficient service multiplexing and provides the forward compatibility required to futureproof 5G. This section explores these key foundational elements that are integral to the 5G NR air interface design. 5G NR will also incorporate a plethora of advanced wireless technologies that will bring new levels of performance and efficiency. It is important to note that the Release 15 specification for 5G NR is not expected to be frozen until 2018, but key decisions are already made during the study item phase that turns into the work item phase in March 2017. Below are 5G design elements from Qualcomm's perspective based on the current status in 3GPP.

## XVI. OPTIMIZED OFDM-BASED WAVEFORMS AND MULTIPLE ACCESS

One of the foremost decisions for designing a unifying 5G air interface is the choice of radio waveform(s) and multiple access technique(s). Not only will they need to deliver high performance at low complexity, but they must also be capable of supporting (and multiplexing) all the envisioned 5G use cases efficiently. Based on this research, the OFDM family is the right choice for 5G enhanced mobile broadband and beyond. This is notable, as this will make 5G the first mobile generation that will not be based on a totally new waveform and multiple access design. Instead, 5G NR will build upon OFDM, which both LTE and Wi-Fi use today, to [3, 33, 34] adapt to meet the extreme variation of 5G requirements. Key benefits of the OFDM family that make it ideal for meeting 5G requirements are:

- Low complexity: it enables low-complexity receivers (e.g., mobile device), even when scaling to wider bandwidths – lowering device cost.
- High spectral efficiency: it allows for low-complexity MIMO implementation that can add more data streams easily – getting closer to Shannon's limit.
- Low power consumption: it can support single-carrier waveforms that have smaller power variations – optimizing PAPR31 for uplink transmissions to deliver more power-efficiency.
- Frequency localization: OFDM allows for enhancements such as windowing/filtering, which can effectively minimize in-band and out-of-band emissions – critical for 5G service multiplexing.

The OFDM family can also efficiently coexist with other waveforms and multiple access schemes in the same framework; for example, supporting asynchronous, grant-free transmissions (e.g., RSMA) for connecting the IoT and enabling mission-critical control communications.

## XVII. A FLEXIBLE FRAMEWORK WITH FORWARD COMPATIBILITY

Supporting the wide range of 5G services and devices requires more than optimized waveforms and multiple access. 5G NR is being designed with a flexible frame structure to efficiently multiplex diverse 5G services and provide forward compatibility for future ones. This equates to flexibility not only in the frequency domain, as discussed earlier with scalable OFDM numerology, but also in the time domain. The 5G NR framework will be able to support the diverse services, features and deployment scenarios envisioned for 5G.[35]

## XVIII. ADVANCED WIRELESS TECHNOLOGIES

5G NR will bring many new inventions across a diverse set of services. This section will highlight some of the key technologies that will allow 5G NR to achieve new levels of performance and efficiency. [30] The focus will be on Release 15 features for enhancing mobile broadband with a brief summary of some key features being envisioned for mission-critical control and massive IoT. 5G enhanced mobile broadband is ushering in the next era of immersive experiences that will require new levels of performance and efficiency, including higher throughput, lower latency, more capacity, higher mobility, and more uniformity at a lower cost. Qualcomm is at the forefront of driving many new technology inventions that will make fiber-like wireless broadband a reality.

## XIX. MILIMETER (MM) WAVE FOR EXTREME CAPACITY AND SPEED

5G NR will not only enable the use of higher frequencies in the 3 to 6 GHz band for macro/small cell deployments, but it will also open up new mmWave opportunities for mobile broadband. The abundant spectrum available at these high frequencies is capable of

delivering extreme data speeds and capacity that will reshape the mobile experience. However, mobilizing the mmWave comes with its own set of challenges.

Transmissions in these higher bands suffer from significantly higher path loss as well as susceptibility to blockage, while meeting the power and form-factor requirements of mobile devices has also proven to be challenging. Thus, traditional mmWave implementations have been limited to mostly stationary applications such as shorter-range wireless docking, enabled by technologies like 802.11ad that operates in the 60 GHz band.

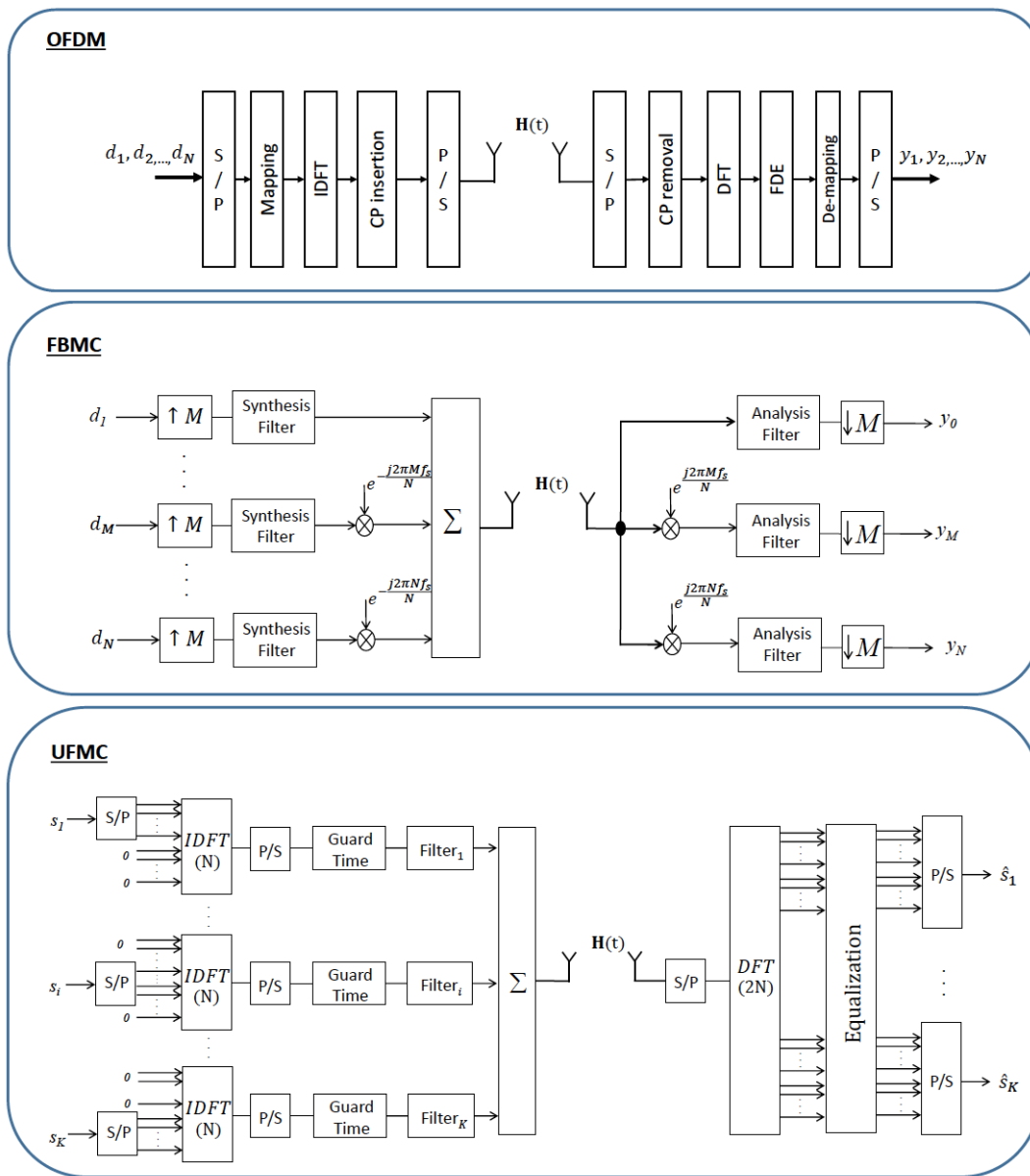
With the recent advancements in signal processing and antenna technologies, the idea of mobilizing the mmWave is no longer out of reach. By utilizing a large number of antenna elements in both the base station and the device, along with intelligent beamforming and beam-tracking algorithms, 5G mmWave can provide increased coverage, reduced interference, and a continuous connectivity experience even for NLOS<sup>49</sup> communications and device mobility. Moreover, 5G NR will also leverage multi-connectivity with 5G sub-6 GHz and/or Gigabit LTE to improve overall link robustness and to help achieve faster system acquisition. Additional design considerations have also been incorporated to enable easy deployment of dense mmWave small cells, such as with the support for integrated access and backhaul.

Qualcomm has been at the forefront of mmWave technologies. Having commercialized 802.11ad 60 GHz chipsets for mobile devices, Qualcomm is also developing and testing early mmWave prototype that operates at 28 GHz band today (scalable to other frequencies). With wider bandwidths, it can easily deliver extreme data rates, but more importantly, it supports robust mobility and handovers that are made possible with our intelligent beamforming and beam-tracking algorithms. [15], [29] Field tests and simulations have shown line-of-sight coverage of ~350 meters and non-line-of-sight coverage of ~150 meters in a dense urban deployment.

## **XX.** OFDM, UFMC, FBMC for 5G NR

This study describes a comprehensive exploration on candidate modulation waveforms in terms of practical network indicators such as good put, delay, fairness and service coverage, and under functional situations that can be imagined to be realistic in 5G deployments. The central idea is on the candidate waveforms: OFDM, UFMC and FBMC for 5G NR. In this work [41], comparison on the performance of the waveforms (OFDM, UFMC, FBMC, and legacy LTE waveforms) in cellular networks with relaxed synchronization are examined. First, an incorporated frame structure is discussed to introduce the context. Comparisons on the robustness of the waveform contenders in the envisaged setting. Based on these outcomes, a bit loading algorithm is proposed to cope with the non-uniform distribution of the interference across the carriers in order to upsurge the spectral efficiency. Comparison between 5G waveform candidates that outperform CP-OFDM: UFMC offers LTE backward compatibility. GFDM and FBMC go further, but there are still open questions on short packet, MIMO, and the likes. [16]

On the other hand, a merging cross-layer framework is suggested that encompasses the downlink preparation and resource division measures that builds upon a model of the queueing process at the data-link control layer and a physical layer abstraction that can be chosen to model either OFDM or FBMC / OQAM. Broad numerical outcomes conclusively show that most of the a priori advantages of FBMC / OQAM over OFDM do indeed interpret into enhanced network indicators, that is, the rise in spectral efficiency achieved by FBMC / OQAM makes up for the distortion caused by the loss of orthogonality.



**Figure 4:** Block diagrams of popular multicarrier schemes (OFDM, FBMC, and UFMC) considered for 5G radio access.

XXI. CHAPTER THREE – OFDM, UFMC AND FBMC

XXII. 5G WAVEFORMS AND PHYSICAL – LAYERS

Physical-layer waveforms have not yet been specified. This is due to the fact that, there is no consensus on potential waveforms, quite a number of candidates are in the running: filter bank multi-carrier (FBMC), generalized frequency division multiplexing (GFDM), universal filtered multi-carrier (UFMC), filtered orthogonal frequency-division multiplexing (F-OFDM), and many more. F-OFDM and FBMC are widely well thought -out by several researchers.

XXIII. WAVEFORM

Waveform portrays the physical shape of a signal that carries the modulated data through a channel. The information is mapped from



the message space to the signal space at the transmitter, and a reverse operation is performed at the receiver to recover the message in a communications system. The waveform, that describes the structure and shape of the information in the signal space, can be characterized by its fundamental elements: symbol, pulse shape, and lattice. The symbols constitute the random part of a waveform whereas the pulse shape and the lattice form the deterministic section.

- Symbol: A symbol is a set of complex numbers in the message space that is formed by assembling a sum of bits together. The number of bits gathered in one symbol regulates the modulation order that has a high influence on the throughput.
- Pulse Shape: The form of the symbols in the signal plane is defined by the pulse shaping filters. The shape of the filters regulates how the energy is spread over the time and frequency domains and has a relevant effect on the signal features.
- Lattice: The lattice is created by sampling the time–frequency plane, and the locations of samples define the coordinates of the filters in the time–frequency grid. The lattice geometry might present different shapes such as rectangular and hexagonal according to the formation and distances between the samples. Also, the lattice can be exploited by involving extra dimensions such as space domain.[42]

Honestly, wireless devices connecting to internet keeps increasing day by day with very fast rate, and this will further intensify in the years to come and it cause of traffic to boost. In order to attain the higher data rate, OFDM is extensively employed in the communication systems due to its benefits as it has the orthogonality between the large numbers of sub-carriers. Multicarrier format is OFDM in which the usable bandwidth is distributed among individual modulated data sources. In 4G system OFDM (Orthogonal Frequency Division Multiplexing) is applied, but it doesn't allow the higher data rate due to the higher Peak to average power ratio and spectrum leakage. To handle these problems new modulation techniques are required. FBMC (Filter Bank Multicarrier) is used to reign over the limitations of OFDM. It is an efficient modulation technique which is ideal for the 5G network or to deliver the new waveforms for 5G.

In this section, some of the 5G waveform candidates will be deliberated on the performance, throughput and efficiency basis. [43]

#### XXIV. SPECTRAL EFFICIENCY

When evaluating the performance of a given modulation and coding system, a prime figure of value is the spectral efficiency which is defined mathematically as:

$$\rho = \frac{R_c N \zeta_g \log_2(M)}{T_s W_{tot}} \text{ b/s/Hz}, \quad (3)$$

where  $R_c$  denotes the rate of the active channel code,  $W_{tot}$  is the total frequency occupancy of the signal according to some measure, and  $\zeta_g \leq 1$  is the inefficiency due to imaginable guard bands in Multicarrier systems, or dually, guard time in single carrier systems.  $M$  denotes the cardinality of the engaged modulation, and  $N$  is the number of subcarriers. Note that spectral efficiency shows here the data rate that can be transmitted for each bandwidth unit used for transmission, irrespective of the underlying bit error rate (BER). To emphasis on the achievable spectral efficiency (ASE), a much more insightful performance measure, representing the spectral efficiency that a system may attain under the constraint of arbitrarily small BER.

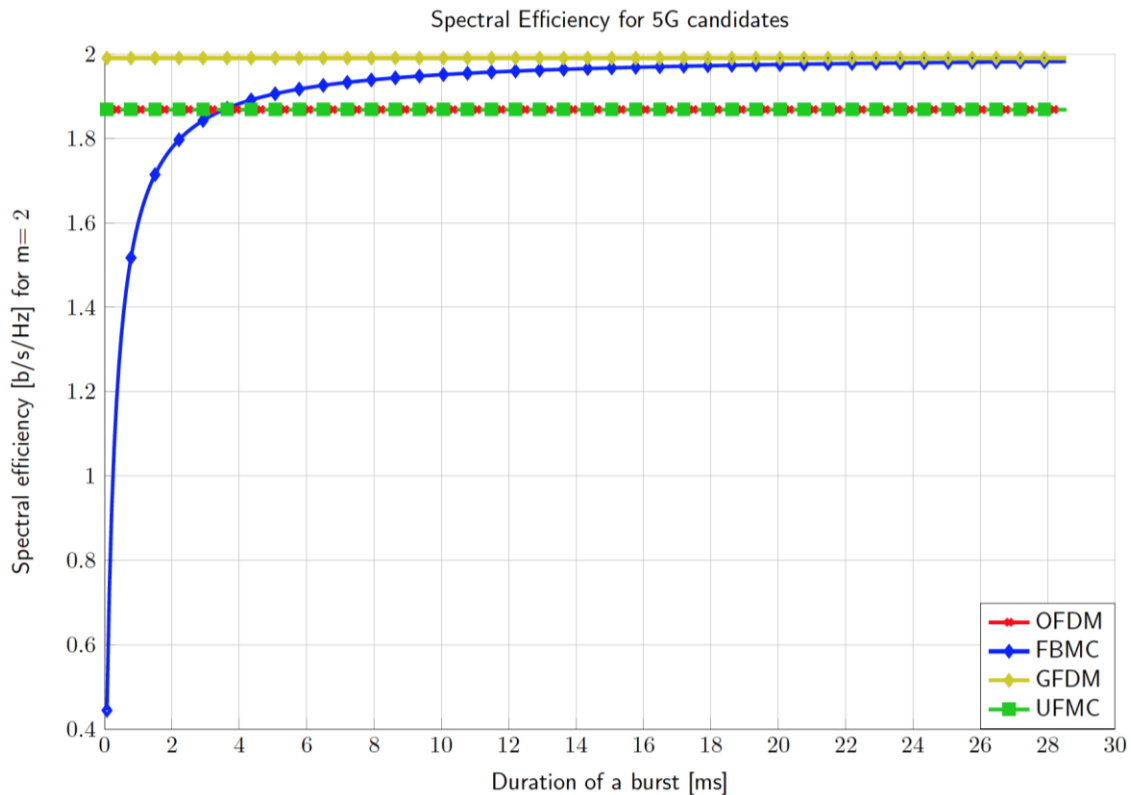
Power Spectral Density of waveforms in this context: OFDM has high ACL due to sinc in frequency domain. UFMC has lower ACL than GFDM (circular convolution). GFDM with windowing: Better OOB than GFDM and comparable to UFMC. Best frequency location is obtained with FBMC.

Simulation parameters & Spectral Efficiency:

1. Considering 2 users for asynchronous multi-user access scheme
  - 3 RBs for user 1 (12 carriers)
  - 9 RBs for user 2 (36 carriers)
2. Same FFT size for all users: 1024
3. Parameters are based on LTE 10MHz
4. Length of UPMC filter has been set to have same Spectral Efficiency for UPMC and OFDM:  $L = N_{CP} + 1$

**Table 3:** Simulation parameters & Spectral Efficiency

<b>Overall parameters</b>		
FFT size	$N_{FFT}$	1025
Bit per Symbol	$m$	2
Resource block size	$N_{RB}$	12
Number of active RBs	$N^{l}_{Re}$	3 for User 1 9 for User 2
Sampling frequency	$F_e$	15.36 MHz
<b>OFDM and SC FDMA parameters</b>		
Cyclic Prefix	$N_{CP}$	72 samples
<b>UPMC Parameters</b>		
Filter Length	$L$	73
Stop band attenuation		40dB
Number of sub symbols	$P$	15
FFT size	$M$	1024
Roll Off factor	$\alpha$	0.1
<b>FBMC parameters</b>		
Spreading factor	$K$	4
<b>Asynchronous Access Parameter</b>		
Guard Carriers		[0,1,2,5]
Timing Offset		[-0.25:0:25]
Carrier Frequency Offset		0;10.5%



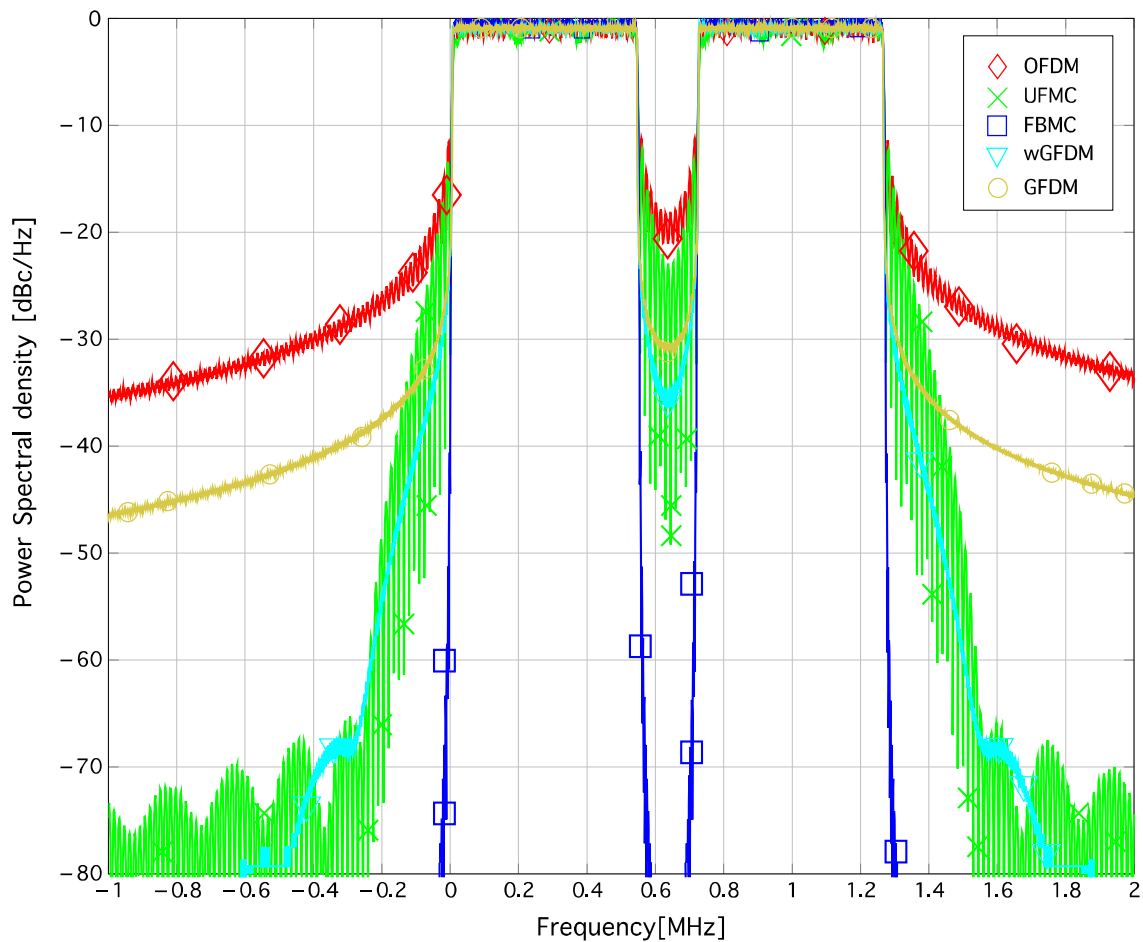
**Figure 5:** Spectral Efficiency for 5G candidates

This figure shows comparisons between SE of waveforms, [16] UPMC and OFDM have the same SE while GFDM SE depends on size block. FBMC SE depends on burst duration: Therefore, If burst duration > 3ms, FBMC has better SE than UPMC and OFDM.

In OFDM, SC-FDMA, GFDM and UPMC, the spectral efficiency does not depend on the burst duration and it is a function of the modulation parameters. But for FBMC-QAM, it depends on the frame duration, and the spectral efficiency loss is due to the transient state of the shaping filter if assumed that no transmission takes place during this period. Hence, there is no constant loss per symbol and the spectral efficiency increases with the burst duration to reach an asymptotic level equal to the modulation order. For GFDM, [31– 33] the spectral efficiency is higher compared to OFDM as a GFDM symbol is M times longer compared to an OFDM one. Indeed, for GFDM, the spectral efficiency loss due to the CP insertion is limited as there is one CP per GFDM symbol (i.e. 1 CP per M equivalent OFDM symbols)

## XXV. POWER SPECTRAL DENSITY

Power spectral density function (PSD) shows the strength of the variations (energy) as a function of frequency. In other words, it shows at which frequencies variations are strong and at which frequencies variations are weak. The [22 ,32] unit of PSD is energy (variance) per frequency(width) and you can obtain energy within a specific frequency range by integrating PSD within that frequency range.



**Figure 6:** Power spectral density of waveforms

This figure shows power spectral density of different waveforms assuming non-contiguous fragments of spectrum available for transmission. It further depicts a better stress the impact of the adjacent channel leakage, the author considered two users that occupy 36 carriers (3 RBs), with 12 guard carriers (1 RB) as guard band. The best spectral localization is obtained with FBMC-OQAM. GFDM has a slightly lower out-of-band leakage compared to OFDM but is clearly outperformed by UPMC. With the addition of the windowing process, GFDM becomes comparable to the UPMC.

Two (2) users of 3 RBs with 1 RB of guard carriers to better stress ACL impact. Spectral Efficiency for each waveform [bit/s/Hz] is given by the following:

$$\eta_{OFDM} = \frac{m \times N_{FFT}}{N_{FFT} + N_{CP}} \quad (3.2)$$

$$\eta_{UPMC} = \frac{m \times N_{FFT}}{N_{FFT} + L - 1} \quad (3.3)$$

$$\eta_{GFDM} = \frac{m \times P \times M}{P \times M + N_{CP}} \quad (3.4)$$

$$\eta_{FBMC} = \frac{m \times S}{S \times K^{-\frac{1}{2}}} \quad (3.5)$$

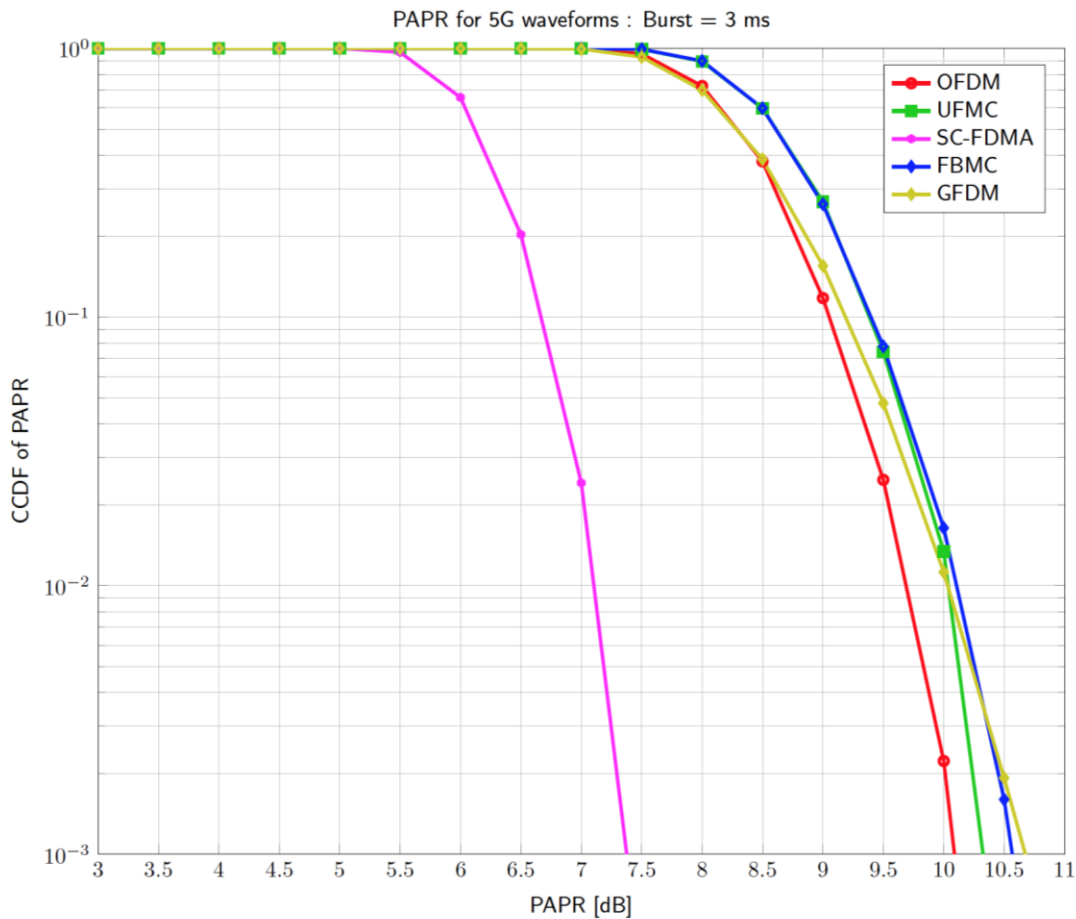
## XXVI. PEAK-TO-AVERAGE POWER RATIO

Peak-to-average power ratio (PAPR) determines the envelope variation of a waveform and is defined as the peak amplitude of the waveform divided by its root-mean-square value. Large PAPR requires power amplifiers to have a very large linear range. Otherwise, the nonlinearity leads to signal distortion, which causes spectral regrowth and higher BER. It was gathered from the literature survey that [44] all multicarrier candidate waveforms suffer from large PAPR. Figure 3.3 presents the PAPR performance comparison of different waveforms and confirms the findings from the literature as it is seen that all the candidate waveforms exhibit large PAPR. Comparing the relative performance, we observe that OFDM and WOFDM have the lowest PAPR while FOFDM shows the highest PAPR. Other MCM schemes using filter to limit OBE also show higher PAPR as compared to OFDM. A general observation from these results is that use of filters in MCM schemes to limit OBE, increases the PAPR due to interference/overlapping among the time domain samples of filtered signals.[34, 36, 37]

PAPR computed on a 3ms burst:

$$PAPR = \frac{\max[|y[k]|^2]}{E[|y[k]|^2]} \quad (3.6)$$

Computing Complementary Cumulative Density Probability Function (CCDF). Low PAPR is only obtained with SC-FDMA. All multicarrier modulations have a comparable PAPR (gap around ~ 0.5 dB) as depicted in figure 3.3



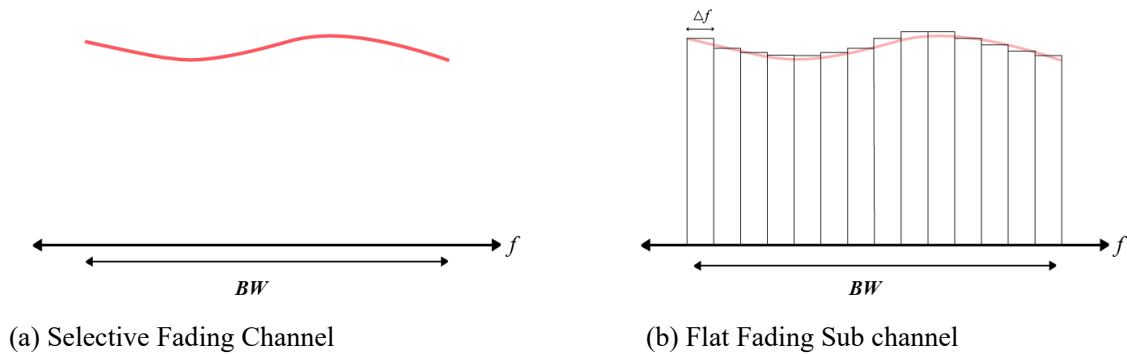
**Figure 7.** PAPR for waveforms with Burst 3ms

To compute on Fig. 7 the CCDF of the PAPR for the considered waveforms, for a burst duration of 3 ms. SCFDMA, due to its (quasi) single carrier property, offers the best performance. The other modulations, which are multicarrier, have a higher PAPR and none of the multicarrier candidates with the chosen parametrization offers better performance than OFDM. However, it should also be noted that the gap is small, around 0.5 dB

## XXVII. MULTI-CARRIER MODULATIONS (SCM)

In classical SCM, the data is conveyed over one single carrier frequency using high transmission rates, which is wide signal bandwidth and short symbol duration. MCM is a group of waveforms in which the information is split and transmitted simultaneously over different carrier frequencies (called sub-carriers) each one with low transmission rates (compared to SCM), thus narrow sub-carrier bandwidth and long symbol duration.[3], [46]

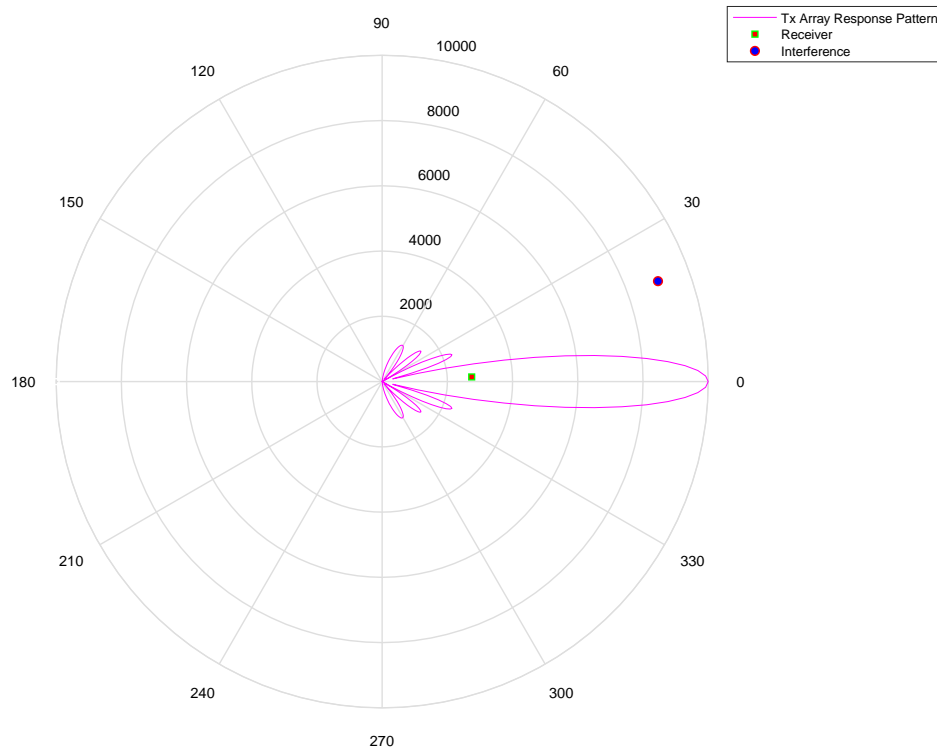
The core benefit of MCM over SCM which makes them liked for high speed wireless transmissions is their robustness against frequency selective fading channels. Their robustness is made clear for the fact that, a selective fading channel can be divided into parallel frequency at fading narrow sub channels in MCM (one for each sub-carrier). This result can be seen in Figure 3.4. Thus, the channel equalization for MCM is a simple process executed in the frequency domain separately for each sub channel. Adversely, in SCM subject to a frequency selective fading channel the equalization is performed in the time domain using complex procedures.[47–49]



**Figure 8.** Effect of dividing a selective fading channel in narrow sub channels

### XXVIII. BEAMFORMING FOR MIMO-OFDM SYSTEMS

To model a point-to-point MIMO-OFDM system with beamforming, The combination of multiple-input-multiple-output (MIMO) and orthogonal frequency division multiplexing (OFDM) techniques have been embraced in current wireless standards, such as 802.11x families, to deliver higher data rate. This is because MIMO uses antenna arrays, beamforming can be employed to enhance the received signal to noise ratio (SNR) which in turn diminishes the bit error rate (BER). The term MIMO is used to refer to a system where multiple transmitters or multiple receivers are present. Practically, the system can take many diverse forms, such as single-input-multiple-output (SIMO) or multiple-input-single-output (MISO) system. Figure 3.5 illustrates a downlink MISO system. An 8-element ULA is arrayed at the base station as the transmitter while the mobile unit is the receiver with a single antenna. The rest of the system is configured as follows. The transmitter power is 8 watts and the transmit gain is -8 dB. The mobile receiver is stationary and situated at 2750 meters away, and is 3 degrees off the transmitter's boresight. An interferer with a power of 1 watt and a gain of -20 dB is positioned at 9000 meters, 20 degrees off the transmitter's boresight. [6]



**Figure 9.** Downlink Multiple Input Single Out (MISO) system.

This example depicts a system level simulation of a point-to-point MIMO-OFDM system employing beamforming. The simulation models and many system components such as encoding, transmit beamforming, precoding, multipath fading, channel estimation, equalization, and decoding.

## XXIX. SIGNAL

Within the transmitter subsystem, there exist fairly a number of components that occur like convolutional encoder, the scrambler, the QAM modulator, the OFDM modulator and so on. The sent signal is first changed to information bits stream and then channels through source coding and the various modulation stages to get ready for radiation. References were made in [23] that data is carried out by the following stages:

- Signal Transmission
- Signal Propagation
- Signal Reception

The modulated carrier is also amplified, and then attached to an antenna that converts the electrical signals to electromagnetic waves for radiation into space. The waves radiate at the speed of light and are transferred not only by line of sight but also by deflection from the ionosphere.

Stating in [50] A radio system conveys information to the transmitter. The information is transmitted through an antenna which transforms the RF signal into an electromagnetic wave. The transmission medium for electromagnetic wave propagation is free space. The electromagnetic wave is interrupted by the receiving antenna which converts it back to an RF signal. Preferably, this RF signal is the same as that originally produced by the transmitter. The original information is then demodulated back to its authentic form. In current wireless standards, the integration of multiple-input-multiple-output (MIMO) and orthogonal frequency division multiplexing (OFDM) formats have taken on to allocate higher data rate. Because MIMO uses antenna arrays, beamforming can be accepted to



enhance the received signal to noise ratio (SNR) which results in reduction of the bit error rate (BER).

The system depicts the level simulation of point-to-point MIMO-OFDM system engaging beamforming. The simulation models have several components for instance encoding, transmit beamforming, precoding, multipath fading, channel estimation, equalization and decoding [51]. The tendency in 5G wireless communication is to attain higher frequencies at millimeter wave spectrum and use enough transmit and receive antennas. Because the path loss in the millimeter wave band is substantial, a larger array is needed to deliver additional beamforming gain to overcome the path loss. In order to be able to command each array element independently to achieve the maximum flexibility in beamforming, a transmit and receive switch often termed as T/R switch, is required behind each element [52].

### XXX. SIGNAL TRANSMISSION

The first procedure is to configure the system's transmitter. There are countless mechanisms in the transmitter subsystem, such as the convolutional encoder, the scrambler, the QAM modulator, the OFDM modulator, and so on. The message is initially converted to an information bit stream and then passed through source coding and modulation stages to be ready for the radiation. Then, the data stream is replicated to all radiating elements in the transmitting array. In a MIMO system, it is possible to detach multiple users' spatial division multiplexing (SDMA). In these conditions, the data stream is often modulated by a weight corresponding to the required direction so that once radiated, the signal is maximized in the exact direction. In a MIMO channel, the signal radiated from diverse elements in an array may go through different propagation environments, the signal emanated from each antenna should be propagated alone. This can be achieved by setting Combine Radiated Signals to false on the phased Radiator component. To get precoding, the data stream radiated from each antenna in the array is modulated by a phase shift corresponding to its radiating direction. The aim of this precoding is to see to it that, these data streams add in phase if the array is steered toward that direction. Precoding can be indicated as weights used at the radiator.

In the intervening time, the array is also driven toward a given steering angle, so the total weights are a mixture of both precoding and the steering weights.

$$weight = wT.* wR \quad (3.7)$$

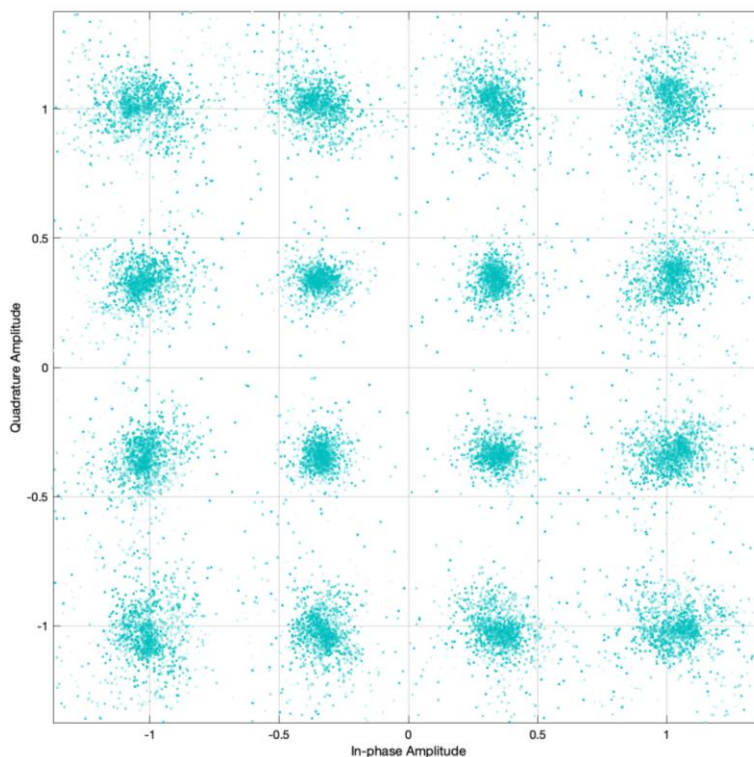
### XXXI. SIGNAL PROPAGATION

Afterwards, the signal propagates through a MIMO channel. In broad-spectrum, there are two propagation effects on the received signal strength that are of concern: one of them is the spreading loss due to the propagation distance, often termed as the free space path loss; and the other is the fading due to multipath. [50], [53] the example in the figure models both effects. To put on a more genuine mobile environment, next section also inserts an interference source. It is noted that, in a wireless communication system, the interference is often a different mobile user.

### XXXII. SIGNAL RECEPTION

The receiving antenna collects both the propagated signal as well as the interference and passes them to the receiver to recover the original information embedded in the signal. [19], [50]. Just like the transmit end of the system, the receiver used in a MIMO-OFDM system also contains many stages, including OFDM demodulator, QAM demodulator, descrambler, equalizer, and Viterbi decoder. An evaluation of the decoded output with the original message stream suggests that the resulting Bit Error Rate (BER) is too high for a communication system.

The constellation diagram is also shown below in figure 10.

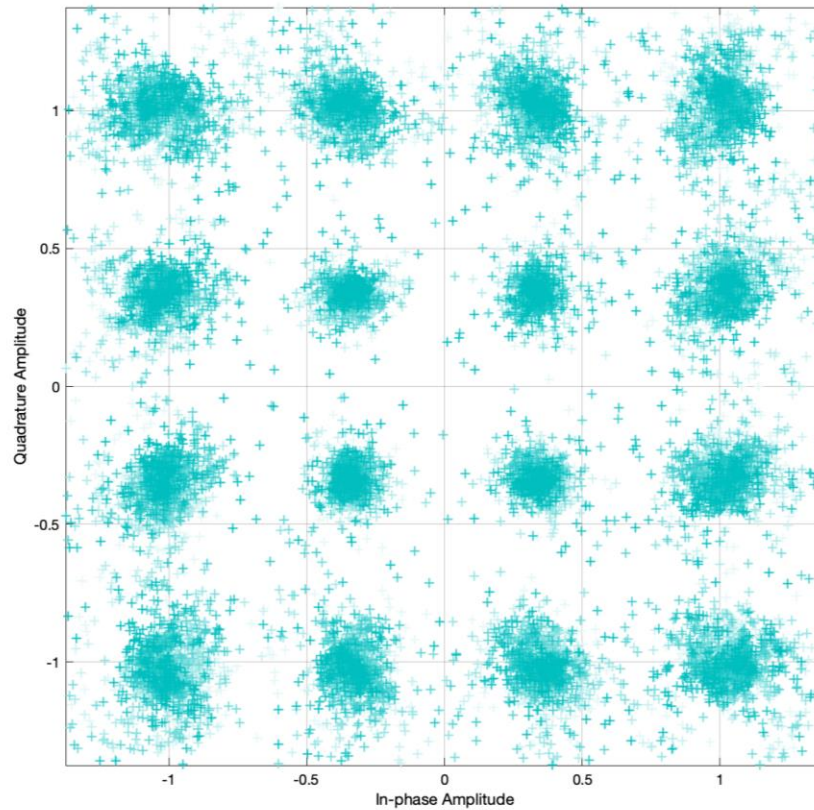


**Figure 10:** Constellation diagram of BER

The high BER is primarily due to the mobile being off the steering direction of the base station array. If the mobile is positioned with the steering direction, the BER is greatly improved. Therefore, the system is very sensitive to the steering error. On the other hand, it is this kind of spatial sensitivity that makes SDMA possible to distinguish multiple users in space.

### **XXXIII.** PHASE SHIFTER QUANTIZATION EFFECT

The dialogue so far adopts that the beam can be handled in the desired direction. In reality, this is often not true, especially when the analog phase shifters are used. Analog phase shifters have only limited precision and are categorized by the number of bits used in phase shifts. For example, a 3-bit phase shifter can only represent 8 different angles within 360 degrees. Thus, if such quantization is included in the simulation, the system performance degrades, [54] which can be observed from the constellation plot in figure 11.



**Figure 11:** Phase Shifter Constellation diagram of BER

For all the modulation formats well-thought-out in this work, the complex baseband equivalent of the transmitted signal, say  $x(t)$ , can be expressed as

$$x(t) = \sqrt{PT_s} \sum_{\ell=-G}^G S_{\ell}(t - \ell T_s) \quad (3.8)$$

where  $P$  is the signal power,  $T_s$  is the symbol period,  $2G + 1$  is the number of temporal slots spanned by each data packet, and the waveform  $S_{\ell}(t)$  is the complex baseband equivalent of the waveform associated to the  $\ell$ th temporal slot [55] [56] which is written as

$$S_{\ell}(t) = \frac{1}{\sqrt{N}} \sum_{k=0}^{N-1} d_{k,\ell} p(t) e^{j2\pi k \frac{\delta f \delta t}{T_s}} (t + \ell T_s) \quad (3.9)$$

In (3.9),  $N$  is the number of subcarriers,  $d_{k,\ell}$  is the transmitted symbol related to the  $(k, \ell)$ th resource element (i.e.,  $k$ th subcarrier and  $\ell$ th symbol interval),  $p(t)$  is the underlying shaping pulse, and  $\delta t$  and  $\delta f$  are two dimensionless constants that rule the actual time and frequency spacing among the transmitted symbols  $d_{k,\ell}$ . In specific, letting  $T$  be a reference symbol time used for normalization and defined as  $T = T_s / \delta t$ , it is seen that symbols  $d_{k,\ell}$  are spaced in time by  $T_s = \delta t T$  and in frequency by  $\delta f \delta t / T_s = \delta f / T$ . Note that letting  $\delta f = \delta t = 1$ , we acquired the usual orthogonality-preserving frequency spacing  $1/T$  that holds for OFDM systems, while the dimensionless product  $\delta f \delta t$  can be interpreted as a measure of how much symbols are packed with respect to the classical OFDM choice. [12]. Merging the two formulas, we attain;

$$x(t) = \sqrt{\frac{PT_s}{N}} \sum_{k=0}^{N-1} \sum_{\ell=-G}^G d_{k,\ell} p(t - \ell T_s) e^{j2\pi k \frac{\delta f \delta t}{T_s} t}. \quad (3.10)$$

Note again that, the shaping pulse  $p(t)$  has no restrictions in its (practically finite) time duration, but it is assumed to be of unit energy, that is;  $\|p(t)\|^2 = 1$ . Furthermore, as specified later, variables  $\{dk, \ell\}$ , the transmitted symbols, are not necessarily equal to pure modulation symbols as they may include some form of signal processing, that, for instance, allows us to consider other (staggered) lattice structures. The pure data symbols are denoted by  $\{ak, \ell\}$ , which we assume to be of unit average power, that is  $E[|ak, \ell|^2] = 1$ . It is easy to show that the above signal model is representative of several modulation formats.

XXXIV. OFDM AND SYSTEM MODEL  
XXXV. ORTHOGONAL FREQUENCY DIVISION MULTIPLEXING

Till date, OFDM has been the dominant technology for broadband multicarrier communications. However, in certain applications such as cognitive radios and uplink of multiuser multicarrier systems, where a subcategory of subcarriers is apportioned to each user, OFDM may be an undesirable solution.[56]. OFDM is a multicarrier communication scheme that has been extensively embraced in a number of diverse wired and wireless communication systems. Among others, 3GPP adopted it as the underlying physical layer (PHY) technology in mobile broadband systems denoted as 4G Long-term Evolution (LTE). It displays some inherent shortcomings as well as frequency leakage caused by its rectangular pulse shape, spectral efficiency loss due to the use of a CP and need for fine time and frequency synchronization in order to preserve the carrier orthogonality, which guarantees a low level of intra and inter-cell interferences [57]. OFDM [58] is multi-carrier digital modulation scheme. The carriers in an OFDM signal are mutually orthogonal to one another over a given time interval thereby minimizing inter-carrier-interference. This allows the sub-carriers to occupy the spectral zero crossing positions of other sub-carriers and hence increasing the spectral efficiency. Due to high spectral efficiency OFDM is being used for data transfer at high rates in 4G wireless networks. An OFDM modulated signal can be generated by carrying out Inverse Discrete Fourier Transform (IDFT) on the digitally modulated signal and correspondingly a DFT operation in the demodulator. In OFDM, the bandwidth  $W$  is equally shared among all the subcarriers. Thus, each subcarrier performs as a narrowband signal but the overall OFDM signal will be wideband signal thus creating the signal immune to frequency selective fading.

In the mist of all the candidates, multicarrier techniques are noticeably exclusive for broadband wireless communications owing to numerous merits such as immunity against frequency selectivity, multiuser diversity support and adaptive modulation /coding techniques. Orthogonal frequency division multiplexing (OFDM) has been the dominating technology so far and successfully deployed in many of the current standards such as Long-Term Evolution (LTE) and Wi-Fi. In the transition from existing technologies (4G) to the next generation, waveform selection ramifies to two paths for 5G RAN. The first one is re-considering OFDM based methods by improving its characteristics and handling its drawbacks with proper solutions. The second one, on the other hand, is to implement alternative multicarrier technologies and redesign everything based on a different rationale. Transceiver block diagrams for OFDM and other popular multicarrier schemes, filtered multi-tone mode of filter bank multicarrier (FBMC), universal filtered multicarrier (UFMC) and generalized frequency division multiplexing (GFDM) are given in Fig. Let us firstly provide the merits and challenges of the multicarrier technologies considered as an alternative to OFDM in the context of 5G expectations [59].

XXXVI. OFDM SYSTEM MODEL

This is a multicarrier approach in which the accessible radio band is shared between original modulated input sources. To add to, the single modulation schemes are Amplitude Modulation, Phase Modulation, Frequency Modulation, Binary Phase Shift Keying and

Quadrature Phase Shift Keying, in these the input is modulated by a single carrier. OFDM is a broadband technology which support data rate in form of 100 megabits per second. Orthogonal Frequency Division Multiplexing (OFDM) is a scheme that gives the overall impression to assign the total accessible radio channels among sub channels. [60] These sub channels are orthogonal with each other. In OFDM the information encoding take place on multiple carrier frequencies. It has proposed into a famous method for widespread digital communication, needed in operations like digital TV and audio broadcasting, DSL internet connection, radio systems, power line structure and 4G mobile communication. OFDM overcome the problem of large bandwidth requirement. In OFDM, cyclic prefix is used to reduce the interference. To overcome the effect of multipath fading problem this occurs in UMTS. The OFDM entails by adding the modulated subcarriers signals transmitted in parallel to IFFT. In general, there is a transmitted signal  $S_n(t)$  for OFDM symbol.

Mathematically, all the carriers can be denoted as a complex waveform as given below:

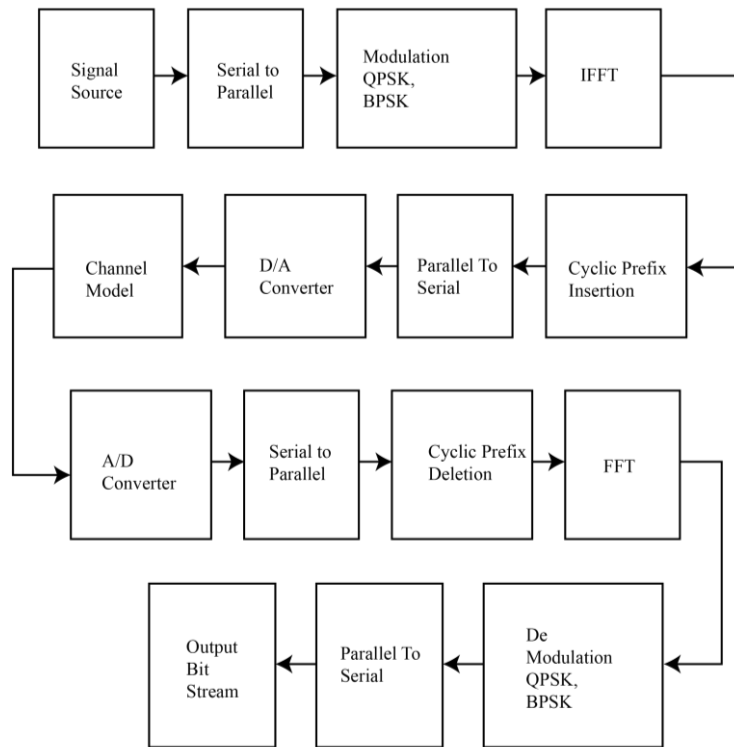
$$S_c(t) = A_c(t)e^{-j[\omega_c t + \phi_c(t)]} \tag{3.11}$$

Where  $S_c(t)$  = Real component of original signal.  $A_c(t)$  = Amplitude. The original data is the actual portion of  $S_c(t)$  mutually  $A_c(t)$  and  $F_c(t)$  is the peak and phase of the carrier, and it can alter on the basis of image by image. The estimations of the specifications are not changeable with the symbol time period (t). It is established that OFDM contains more than one carrier. Therefore the complex signals  $S_c(t)$  is expressed the equation:

$$S_c(t) = 1/N \sum_{n=0}^{N-1} A_n(t) e^{j[\omega_n t + \phi_n(t)]} \tag{3.12}$$

Here:  $\omega_n = \omega_0 + n\Delta\omega$  .It is in form of continuous signal. If we calculate the waveform of every part or elements of signal over a solo symbol duration, at that point, the terms  $A_c(t)$  and  $F_c(t)$  reaction to the not changeable data that rely upon the frequency of that special carrier, and this can be written as:

$$\begin{aligned} \Phi_n(t) &= \phi_n \\ A_n(t) &= A_n \end{aligned}$$



**Figure 12:** OFDM Transmitter / Receiver Architecture

If the input data is sampled with the use of a sampling frequency  $1/T$ , then the output data is depicted as following:

$$S_s(kT) = 1/N \sum_{n=0}^{N-1} A_n e^{j[\omega_0 + n\Delta\omega]kT + \phi_n} \quad (3.13)$$

Here, we are bound to the time by which we analyses the signal to  $N$  samples. This is appropriate than the time of a single information symbol. This can be exemplified as:

$$T = NT$$

Equation (3.13) without any loss of quality by assuming  $\omega_0 = 0$ , then the signal is:

$$S_s(kT) = 1/N \sum_{n=0}^{N-1} A_n e^{j\phi_n} e^{j(n\Delta\omega)kT} \quad (3.14)$$

By comparing the equation (3.14) with Inverse Fourier Transform we obtain:

$$g(kT) = 1/N \sum_{n=0}^{N-1} G(n/NT) e^{j2\pi nk/N} \quad (3.15)$$

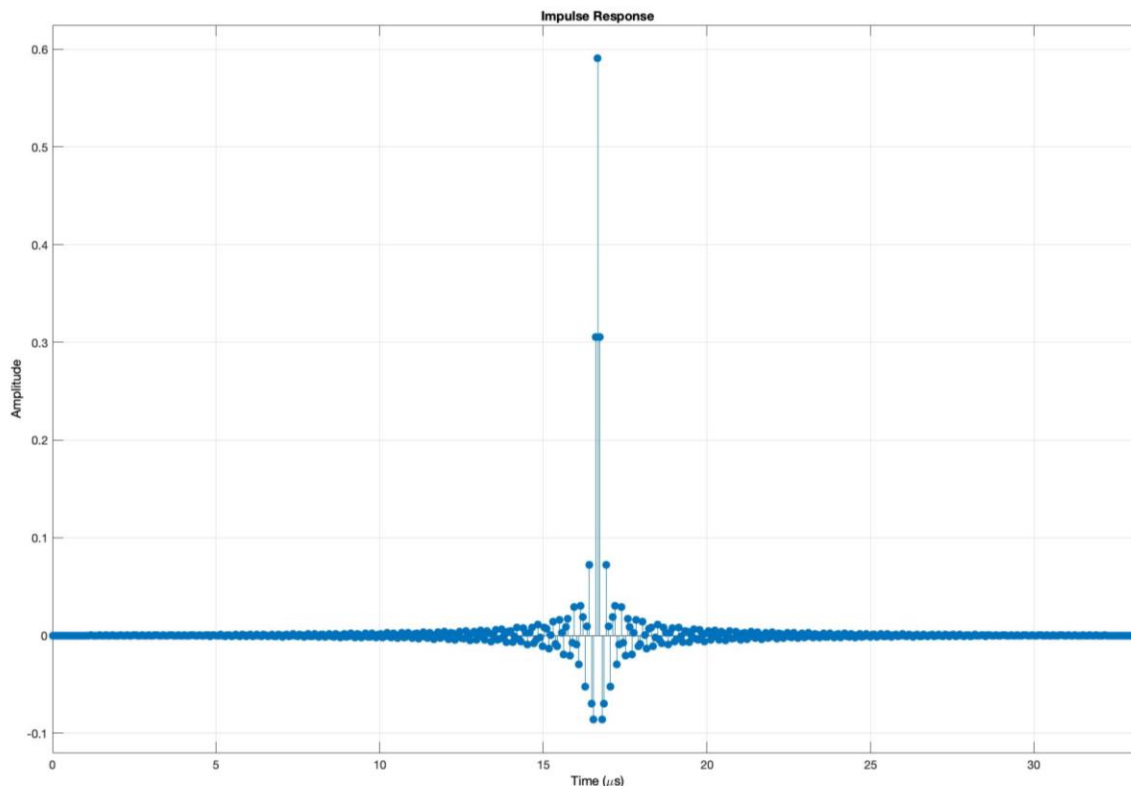
In equation (3.14), the term  $A_n e^{j\phi_n}$  is not larger from a clarification of the signal in an inspected recurrence domain, also  $s(kT)$  is the time domain image. OFDM is a multicarrier modulation technique. As soon as numerous of carriers are positioned close to each

other, then it creates the OFDM signal. The sidebands enlarge out to one side, once the modulation of any data or information takes place and applied to the carrier. It is obligatory for the receiver that it should be able to obtain the full signal to get original signal back efficiently. When signals are sent near to each other, they have to be positioned as that the recipient can differentiate those with the use of filter and there should be guard interval among them. But in the situation where OFDM subcarrier sidebands overlaps with each other, they can be gained without any interference, because of the orthogonality property. This can be achieved by getting the carrier difference equal to the inverse of symbol duration.

### XXXVII. FILTERED-OFDM FILTER DESIGN

A suitable filtering for F-OFDM normally satisfies these criteria: Must have a flat passband over the subcarriers in the sub-band, Should have a sharp transition band to minimize guard-bands and should have enough stop-band attenuation

A filter with a rectangular frequency response, that is to say; a sinc impulse response, meets these standards. To make this causal, the low-pass filter is seen using a window, which, effectively abbreviates the impulse response and delivers smooth transitions to zero on both ends.

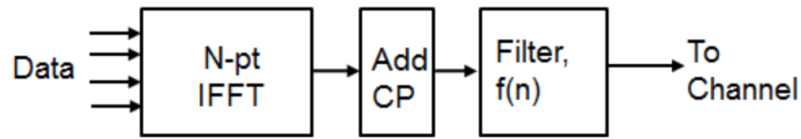


**Figure 13:** OFDM Impulse Response

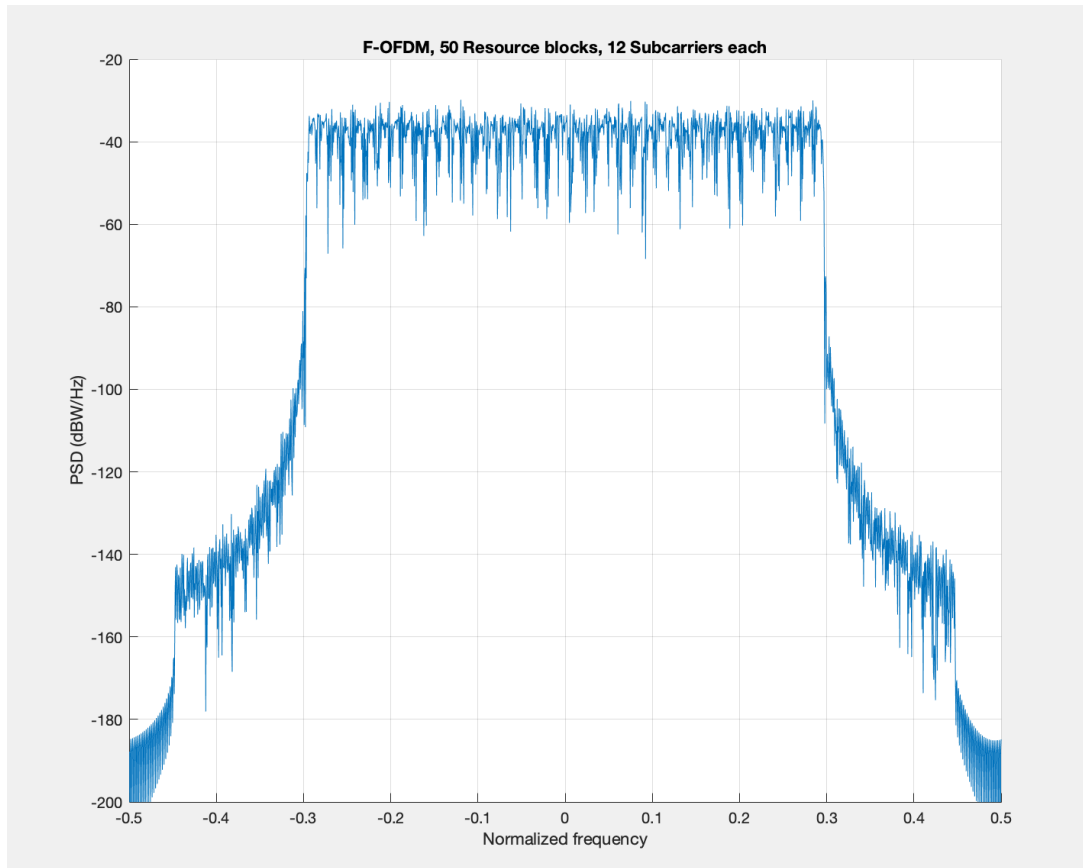
### XXXVIII. F-OFDM TRANSMIT PROCESSING

In F-OFDM, the sub-band CP-OFDM signal is channeled through the designed filter. As the filter's passband corresponds to the signal's bandwidth, only the few subcarriers near the edge are impacted. A key deliberation is that the filter length can be permitted to surpass the cyclic prefix length for F-OFDM [61]. The inter-symbol interference incurred is diminished due to the filter design using windowing (with soft truncation).

Transmit-end processing procedures are shown in the following F-OFDM transmitter diagram.



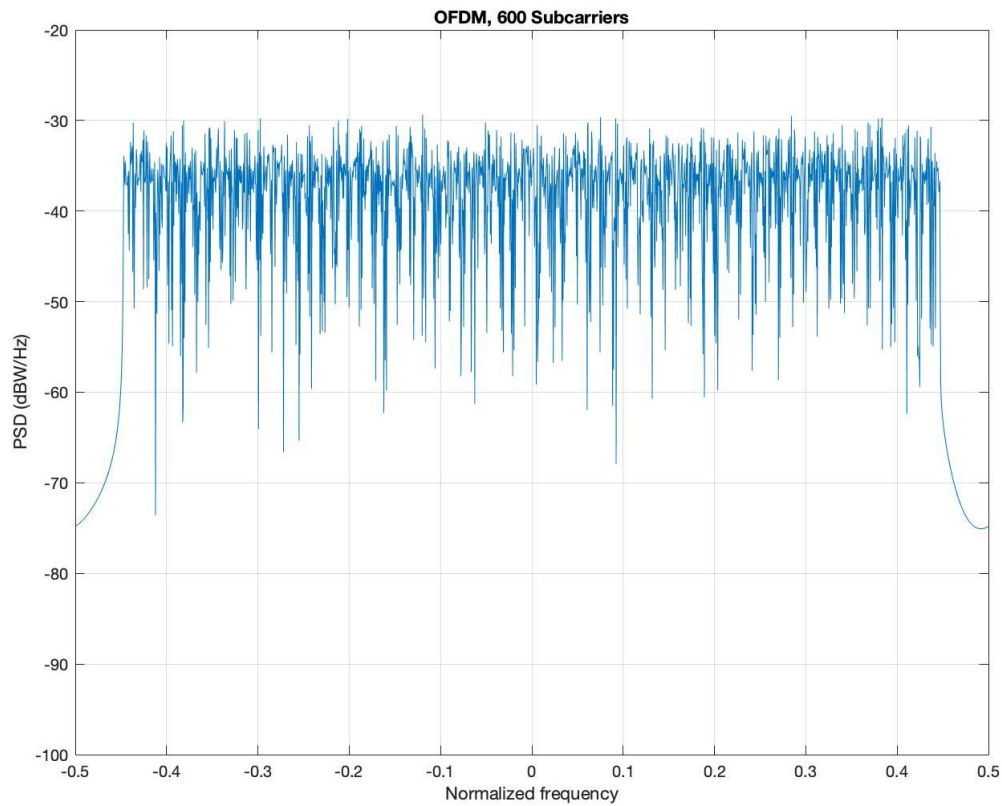
**Figure 14:** Filtered – OFDM Transmitter



**Figure 15:** Power Spectral Density for F-OFDM.

OFDM Modulation with Corresponding Parameters. For assessment, we examine the existing OFDM modulation technique, using the full employed band, with the same length cyclic prefix. Likening the plots of the spectral densities for CP-OFDM and F-OFDM schemes, F-OFDM has lesser side lobes. This permits a higher utilization of the given spectrum, leading to increased spectral efficiency.

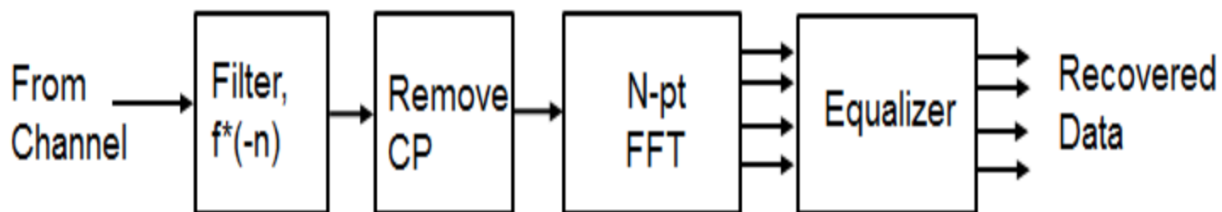




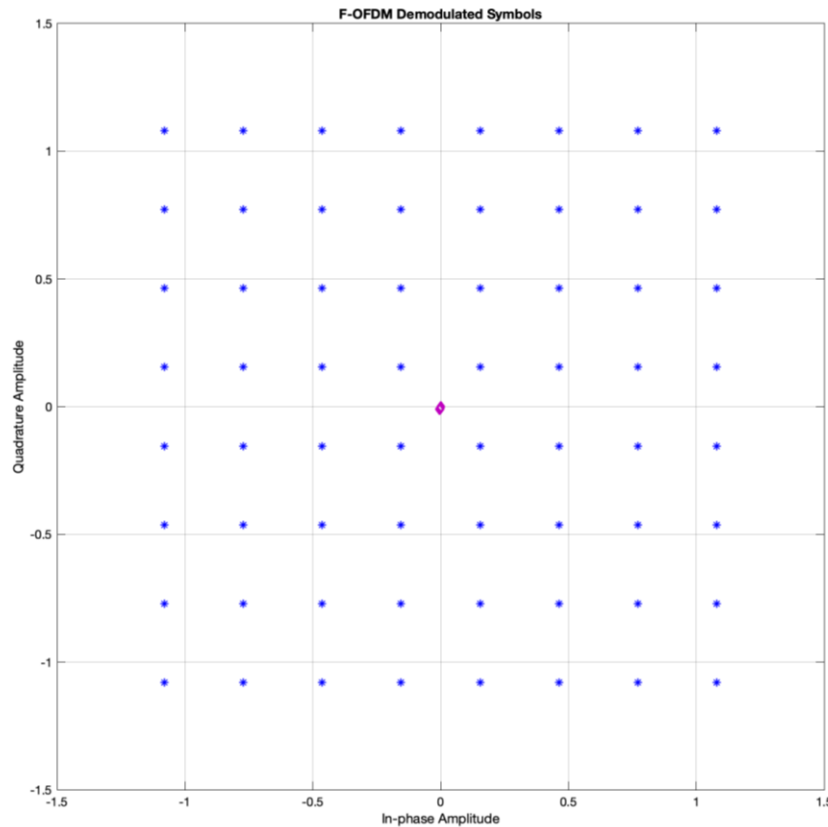
**Figure 16:** Power Spectral Density for OFDM

**XXXIX.** F-OFDM RECEIVER WITH NO CHANNEL

Figure 17 below highlights the basic receive processing for F-OFDM for a single OFDM symbol. The gained signal is passed through a matched filter, followed by the normal CP-OFDM receiver. It accounts for both the filtering ramp-up and latency prior to the FFT operation. There is no fading channel considered in this figure but noise is added to the received signal to achieve the desired SNR. Receive processing operations are shown in the F-OFDM receiver diagram below.



**Figure 17:** F-OFDM Receiver



**Figure 18:** F- OFDM Demodulated Symbols

As emphasized, F-OFDM adds a filtering stage to the prevailing CP-OFDM processing at both transmit and receive ends. The illustration models the full-band allocation for a user, but the same method can be used for multiple bands (one per user) for an uplink asynchronous operation. These presents the basic characteristics of the F-OFDM modulation scheme at both transmit and receive ends of a communication system [62]. Discover different system parameter values for the number of resource blocks, number of subcarriers per blocks, filter length, tone offset and SNR. Universal Filtered Multi-Carrier (UFMC) modulation scheme is another method to sub-band filtered OFDM. F-OFDM example uses a single sub-band while the UFMC example uses multiple sub-bands. F-OFDM and UFMC both use time-domain filtering with subtle differences in the way the filter is designed and applied. For UFMC, the length of filter is controlled to be equal to the cyclic-prefix length, while for F-OFDM, it can surpass the CP length. For F-OFDM, the filter design points to a slight loss in orthogonality (strictly speaking) which affects only the edge subcarriers.

XL. CHAPTER FOUR - RESULTS AND DISCUSSION

XLI. INTRODUCTION

In this chapter the remaining multicarrier modulation formats that have been proposed by the EU-funded research 5GNOW and are promising for comparing with OFDM are extensively discussed. OFDM, as a multi-carrier modulation technique, has been widely adopted by 4G communication systems, such as LTE and Wi-Fi®. It entails many pros: robustness to channel delays, single-tap frequency domain equalization, and efficient implementation. What is often not emphasized are its costs involved such as the loss in spectral efficiency due to higher side-lobes and the strict synchronization requirements. New modulation processes are, thus, being

considered for 5G communication systems to overcome some of these factors. To overcome these limitations in OFDM, several alternative candidates have been intensively studied in the literature over the past few years, such as universal filtered multi carrier (UFMC).

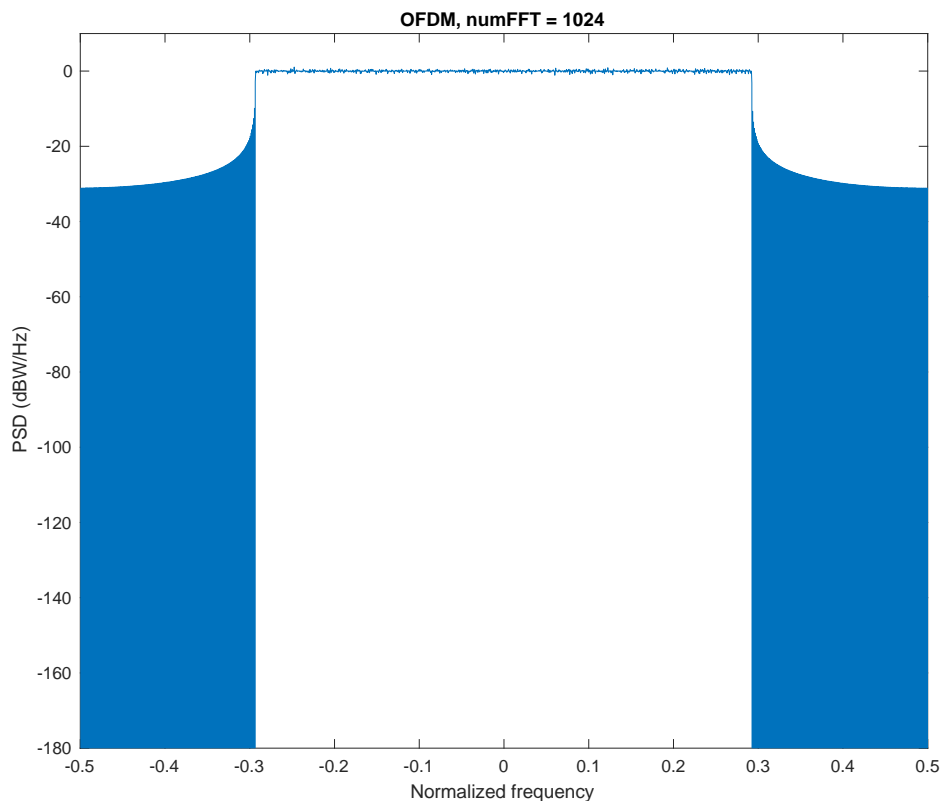
Again, FBMC was considered as an alternate waveform to OFDM in the 3GPP RAN study phase I during 3GPP Release 14. According to Math Works Inc. FBMC is similar to OFDM except that FBMC does not use the cyclic prefix (CP) which is totally a waste of the bandwidth.

## XLII. OFDM

OFDM has recently been applied in wireless communication systems due to its high data rate transmission capability with high bandwidth efficiency and its robustness to multi-path delay. Fading is the one of the major aspect which is considered in the receiver. To omit the effect of fading, channel estimation and equalization procedure must be done at the receiver before data demodulation.

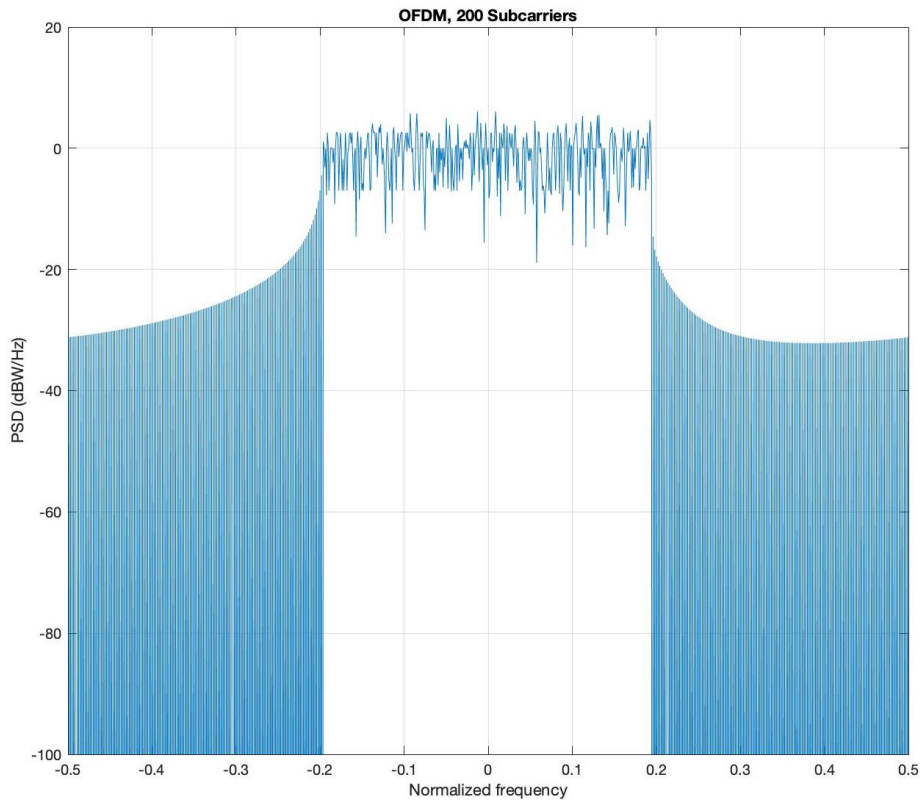
## XLIII. F-OFDM VS. OFDM MODULATION

According to Math Works Inc. [63] These instances relates Orthogonal Frequency Division Multiplexing (OFDM) with Filtered-OFDM (F-OFDM) and throws more light on the merits of the candidate modulation scheme for Fifth Generation (5G) communication systems. Comparing Filtered-OFDM modulation with generic Cyclic Prefix OFDM (CP-OFDM) modulation. For F-OFDM, a well-designed filter is applied to the time domain OFDM symbol to improve the out-of-band radiation of the sub-band signal, while maintaining the complex-domain orthogonality of OFDM symbols. The figure models Filtered-OFDM modulation with configurable parameters. It places a lot of interest on the filter design technique and the basic transmit /receive processing.



**Figure 19: OFDM Power Spectral Density**

In Figure 19, OFDM PSD curve has larger side lobes and out of band radiation. Thus the FBMC technique is additional beneficial in contrast to OFDM by giving larger spectral effectiveness. Because of each carrier filtering, it experiences a higher filter delay and requires OQAM processing also. Comparing the plots of the spectral densities for OFDM and FBMC schemes, FBMC has lower side lobes. This allows a higher utilization of the allocated spectrum, leading to increased spectral efficiency. OFDM Modulation with Corresponding Parameters For assessment, we evaluate the existing OFDM modulation technique, using the full occupied band, however, without a cyclic prefix. Given a Peak-to-Average-Power-Ratio (PAPR) for OFDM as 8.8843 dB.



**Figure 20:** OFDM PSD with 200 Subcarriers

#### **XLIV.** UNIVERSAL FILTERED MULTICARRIER (UFMC)

UFMC is a generalized version of filtered multicarrier techniques where groups of subcarriers, thus sub-bands, are filtered instead of filtering each subcarrier independently. By doing so, interference between neighboring sub-bands is reduced compared to conventional OFDM. Again, sub-band based filtering operation, when compared to the subcarrier filtering operation performed by FBMC, aims to increase the efficiency for short-burst type communications such as IoT scenarios or very low latency packets by reducing the filtered symbol duration and outperforms both cyclic prefix (CP)-OFDM and FBMC for such use cases. [53– 55] A comparable scheme is also given as resource block (RB)-filtered OFDM. Nevertheless, while UFMC aims to solve the problems of FBMC and maintaining its advantages, the increased fast Fourier transformation (FFT) length introduces complexity issues at the transmitter and receiver operations.

The aspects of Universal Filtered Multi Carrier (UFMC) system and emphasis, gives the advantages of new modulation method for the emerging fifth generation (5G) Wireless Communication Systems [67]. UFMC waveform is a derivative of OFDM waveform combined with post-filtering, where a group of carriers is filtered by using a frequency domain efficient implementation. This sub-band filtering operation is inspired by the fact that the smallest unit used by the scheduling algorithm in frequency domain in 3GPP

LTE is a resource block (RB), which is a group of 12 carriers. The filtering operation leads to a lower out-of-band leakage than for OFDM. The UFMC transmitter is composed of B sub-band filtering that modulate the B data blocks. The transmitted signal uses no CP, but there is still a spectral efficiency loss due to the time transient (tails) of the shaping filter. The Rx stage is composed of a 2NFFT point FFT, which is then decimated by a factor 2 to recover the data. A windowing stage can also be inserted before the FFT. It introduces interference between carriers but is interesting to consider for asynchronous uplink transmissions as it aids to separate contiguous users.

### XLV. UNIVERSAL FILTERED MULTI-CARRIER MODULATION

UFMC is seen as a broad view of Filtered OFDM and FBMC (Filter Bank Multi-carrier) modulations techniques. The whole band is filtered in filtered OFDM and single subcarriers are filtered in FBMC, while groups of subcarriers (sub-bands) are filtered in UFMC. This subcarrier grouping permits one to minimize the filter length (when compared with FBMC). Furthermore, UFMC can still use QAM as it retains the complex orthogonality (when compared with FBMC), which works with existing MIMO schemes. The full band of subcarriers ( $N$ ) is divided into sub-bands, where each sub band has a fixed number of subcarriers and not all sub-bands need to be employed for a given transmission. An  $N$ -pt IFFT for each sub band is computed, inserting zeros for the unallocated carriers. Each sub band is filtered by a filter of length  $L$ , and the responses from the different sub-bands are summed. The filtering is done to reduce the out-of-band spectral emissions. Different filters per sub-band can be applied, however, in this example, the same filter is used for each sub-band. A Chebyshev window with parameterized side-lobe attenuation is engaged to filter the IFFT output per sub-band.

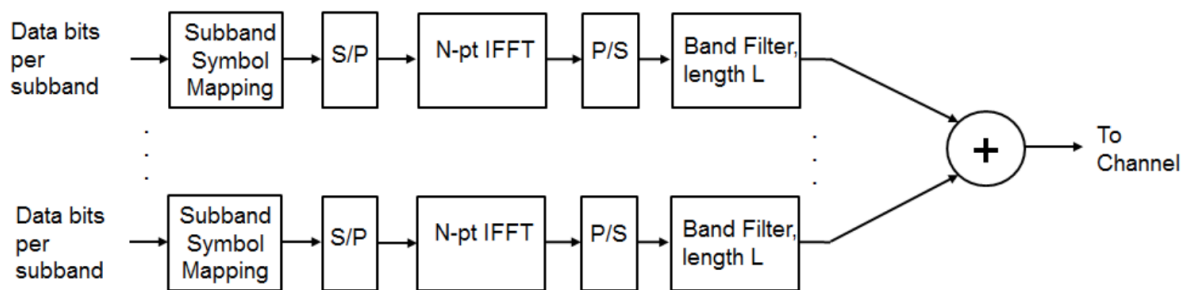
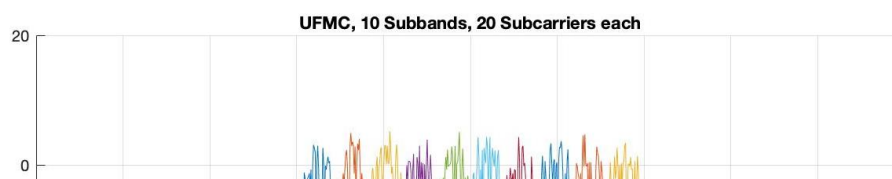


Figure 21: UFMC Transmitter Diagram

In figure 22 below, an LTE system at 20 MHz channel bandwidth uses 100 resource blocks of 12 subcarriers each, at an individual subcarrier spacing of 15 kHz. This utilizes only 18 MHz of the assigned spectrum, resulting to a 10 percent loss. Furthermore, the cyclic prefix of 144 or 160 samples per OFDM symbol leads to another ~7 percent efficiency loss, for an overall 17 percent loss in possible spectral efficiency. With the now defined ITU requirements for 5G systems, applications require much higher data rates, lower latency and more efficient spectrum usage.



### **Figure 22: PSD for UFMC**

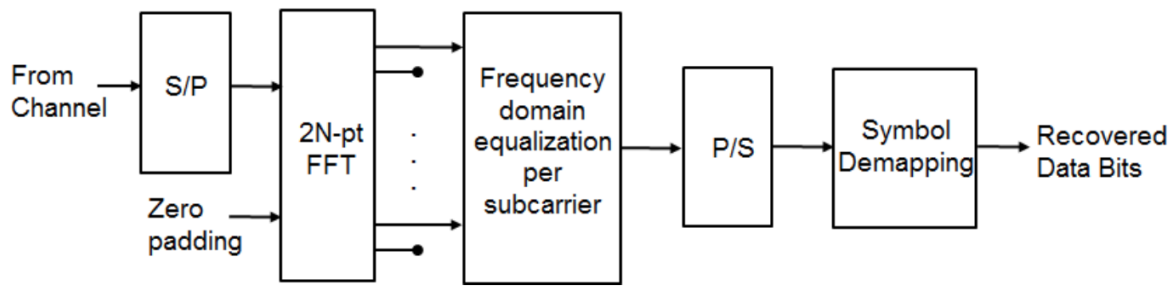
This figure focuses on the new modulation technique known as Universal Filtered Multi-Carrier (UFMC) compares it with OFDM within a generic framework in figure 4.2 given a Peak-to-Average-Power-Ratio (PAPR) for UFMC equals 8.2379 dB. Associating the plots of the spectral densities for OFDM and UFMC structures, UFMC has lower side-lobes. This allows a higher utilization of the given allocated spectrum, resulting to increased spectral efficiency. UFMC also shows to some extent better PAPR.

### **XLVI. UFMC RECEIVER WITH NO CHANNEL**

The figure next highlights the basic UFMC receive processing, which, like OFDM, is FFT-based. The sub-band filtering extends the receive time window to the next power-of-two length for the FFT operation. Every alternate frequency value corresponds to a subcarrier main lobe. In typical scenarios, per-subcarrier equalization is used for equalizing the joint effect of the channel and the sub-band filtering. In the diagram below, only the sub-band filter is equalized because no channel effects are modeled. Noise is added to the received signal to achieve the desired SNR.

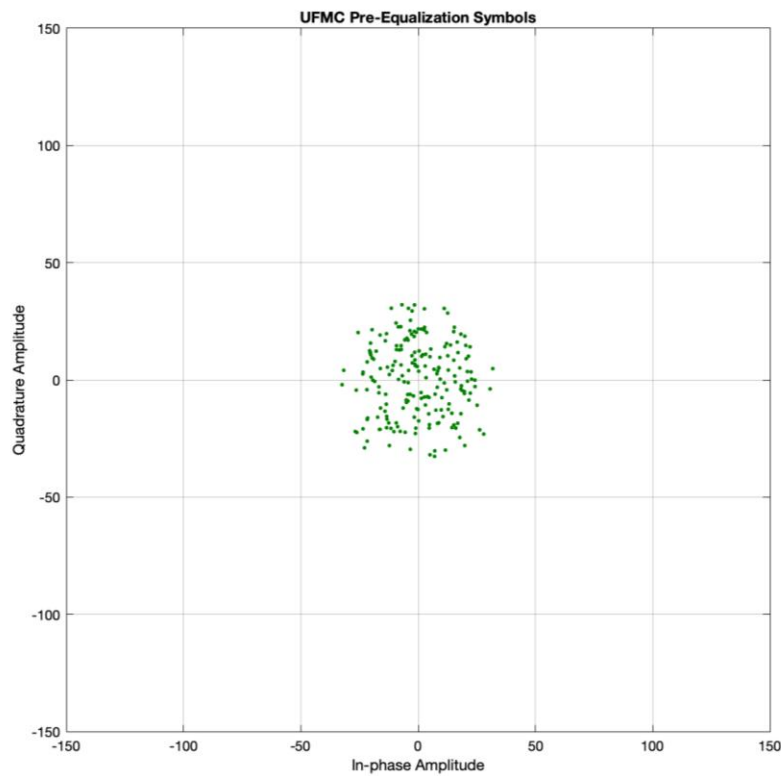
UFMC Reception, has BER = 0 at SNR = 15 dB

The receive-end processing is shown in the following diagram.

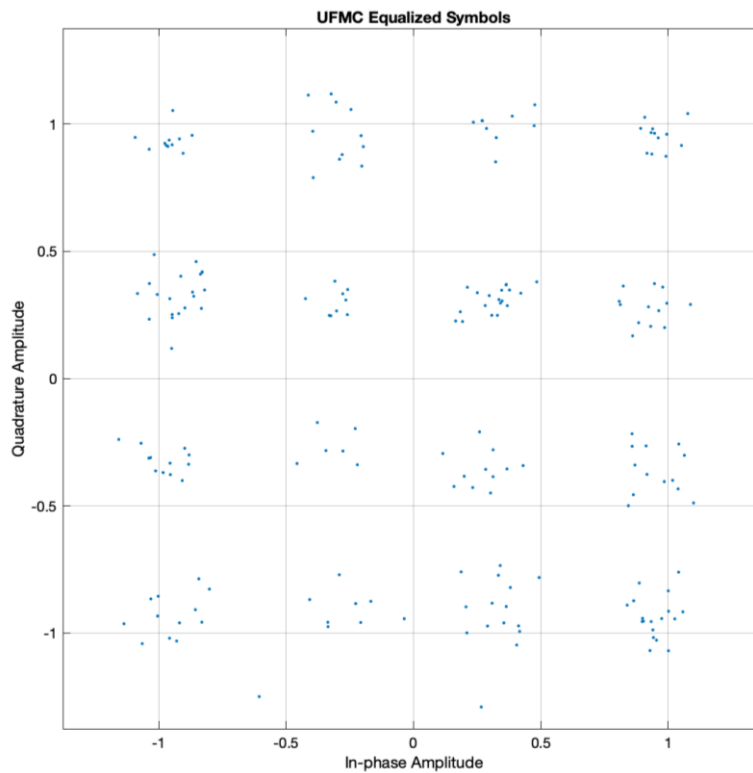


**Figure 23:** UFMC Receiver with no channel

The illustration portrays the basic features of the UFMC modulation scheme at both transmit and receive ends of a communication system. Discover diverse system parameter values for the number of sub-bands, number of subcarriers per sub-band, filter length, side-lobe attenuation, and SNR.



**Figure 24:** UFMC Pre-Equalization Symbols



**Figure 25:** UPMC Equalized Symbols.

UPMC is considered advantageous in relation to OFDM by offering higher spectral efficiency. Sub-band filtering has the advantage of decreasing the guards between sub-bands and also reducing the filter length, which makes this scheme good-looking for short bursts. The latter property also makes it attractive in comparison to FBMC, which suffers from much longer filter length.

## **XLVII.** FILTER-BANK MULTICARRIER (FBMC)

FBMC is one of the most well-known multi-carrier modulation formats in wireless communications literature which is also talked about as a 5G waveform. It proposes a great benefit of shaping each subcarrier and enable a flexible utilization of spectral resources along with meeting various structural requirements, For Instance: low latency, multiple access etc. This is also a benefit for making signal robust against channel effects thus. Dispersion in time and frequency domains. For example, rectangular filters are preferable for time dispersive channels while raised cosine filter are more robust against frequency dispersion.[68] Several other pulse shaping filters are also explored in the literature to cope with various effects of the channel and provide a reliable system design based on different scenarios. FBMC was considered as an alternate waveform to OFDM in the 3GPP RAN study phase I during 3GPP Release 14. According to Math Works Inc.[69]. FBMC is similar to OFDM except for the reason that FBMC does not use the cyclic prefix (CP) which is totally wastage of the bandwidth, it also provides the better spectral efficiency. [43] Cyclic prefix is basically a term used to reduce the interference by transmitting the copy of 10 to 25% of the LSB (Least significant bits) or end bits of symbol to the front of each MSB (Most significant bits).[70] Yet, FBMC utilizes the bandwidth in an effective way by using filter banks on the transmitter side and receiver side. FBMC technique delivers higher data rate than OFDM due to the reduction of guard bands. It also provides the capability to allot the distinct sub-carrier to the distinct non synchronized consumers or users in effective and suitable way.

The restrictions of FBMC is that it is complex due to use of filter banks on both sides' thus, transmitter and receiver sides. In upcoming cellular system, filter bank multicarrier technology raises the spectral efficiency and utilizes the radio band perfectly and



provides the accurate or suitable waveforms for next generation communication system. In spite of all the advantages FBMC has, the importantly long filter lengths resulting in colossal symbol durations not only becomes a problem if low latency applications or short bursts of machine type communications are in focus, but also introduces an extreme computational complexity for MIMO detection as the channel coherence bandwidth would fall below.

FBMC waveform is made up of set of parallel data that are transmitted through a bank of modulated filters. The prototype filter, parametrized by the overlapping factor  $K$ , can be selected to have very low adjacent channel leakage. One may distinguish between two main variants of FBMC: one based on complex (QAM) signaling, which is also termed as filtered multi tone (FMT), and another based on real valued offset QAM (OQAM) symbols, also referred to as FBMC/OQAM. The latter ensure orthogonality in real domain to boost spectral efficiency. The first variant (FMT) is currently employed in standards like Telecommunication Equipment Distribution Service (TEDS), and attains orthogonality in the midst of subcarriers by physically reducing their frequency domain overlapping, thus reducing the SE in a similar proportion as CP-OFDM [57]. Associating Filter Bank Multi-Carrier (FBMC) with Orthogonal Frequency Division Multiplexing (OFDM), the relevance discussed highlights their merits of the candidate modulation scheme for Fifth Generation (5G) communication systems. Compares Filter Bank Multi-Carrier (FBMC) modulation with generic OFDM modulation. FBMC offers ways to overcome the known limitations of OFDM of reduced spectral efficiency and strict synchronization requirements. These advantages have given it the opportunity to be considered as one of the modulation techniques for 5G communication systems.

### XLVIII. FILTER BANK MULTI-CARRIER MODULATION

FBMC filters each subcarrier modulated signal in a multicarrier structure. The prototype filter is the one used for the zero-frequency carrier and is the basis for the other subcarrier filters. The filters are characterized by the overlapping factor,  $K$  which is the number of multicarrier symbols that overlap in the time domain. The prototype filter order can be chosen as  $2*K-1$  where  $K = 2, 3,$  or  $4$  and is selected as per the PHYDYAS project. The current FBMC implementation uses frequency spreading. It uses an  $N*K$  length IFFT with symbols overlapped with a delay of  $N/2$ , where  $N$  is the number of subcarriers. This design choice makes it easy to analyze FBMC and compare with other modulation methods. To achieve full capacity, offset quadrature amplitude modulation (OQAM) processing is employed. The real and imaginary parts of a complex data symbol are not transmitted simultaneously, as the imaginary part is delayed by half the symbol duration.

The transmit-end processing is shown in the following diagram below:

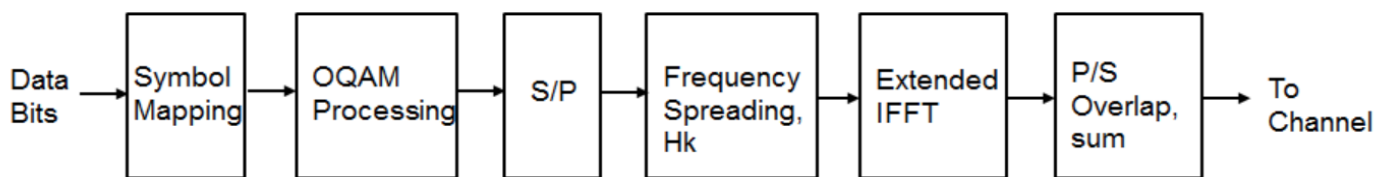
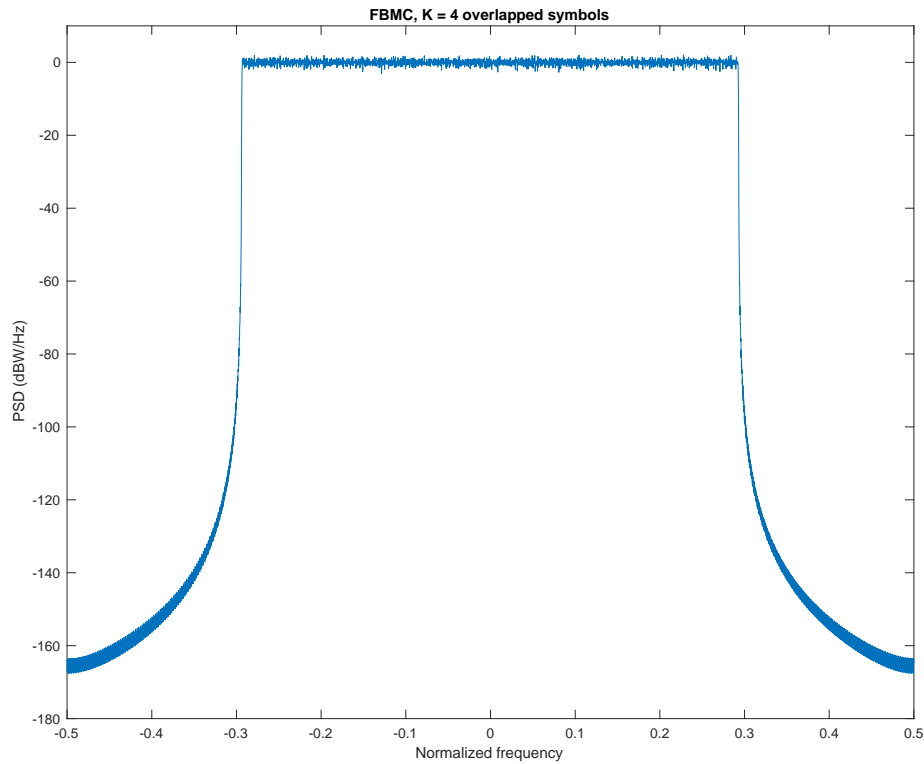


Figure 26: FBMC Transmitter,



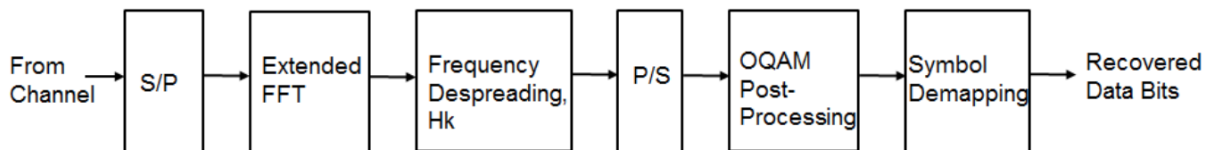
**Figure 27:** FBMC Power Spectral Density

Figure 27 represents that the, FBMC has lower side lobes. This allows an advanced use of the allocated band, leading to advanced spectral efficiency. A review of the existing OFDM modulation technique, using the full occupied band, however, without a cyclic prefix. The power spectral density of the FBMC transmit signal is plotted to highlight the low out-of-band leakage.

### **XLIX. FBMC RECEIVER WITH NO CHANNEL**

The example implements a basic FBMC demodulator and measures the BER for the chosen configuration in the absence of a channel. The processing includes matched filtering followed by OQAM separation to form the received data symbols. These are de-mapped to bits and the resultant bit error rate is determined. In the presence of a channel, linear multi-tap equalizers may be used to mitigate the effects of frequency-selective fading.

The receive-end processing is shown in the following diagram.

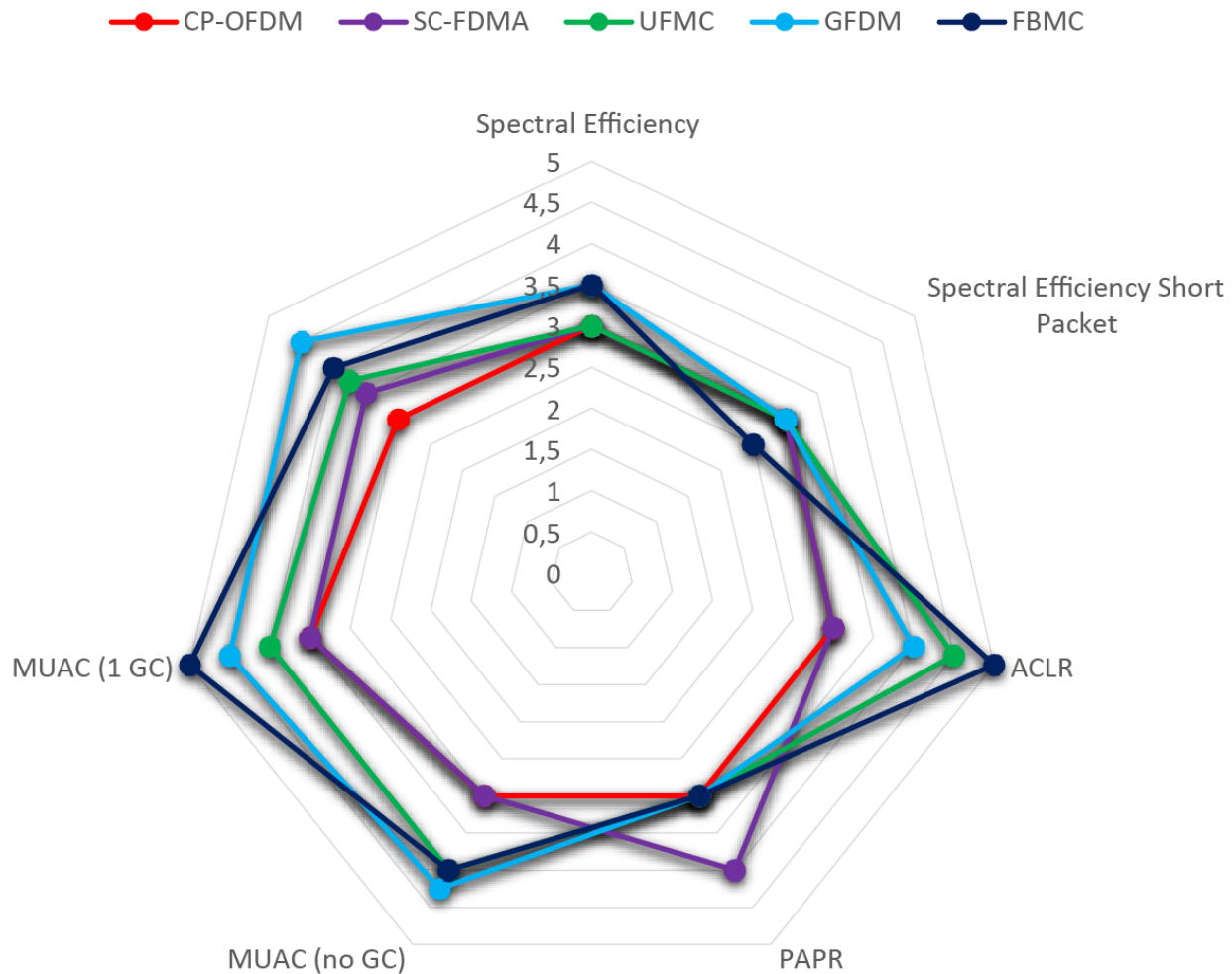


**Figure 27:** FBMC Receiver

FBMC Reception for K = 4, BER = 0 at SNR = 12 dB. The figure presented the basic transmit and receive characteristics of the FBMC modulation scheme. Exploring by changing the number of overlapping symbols, FFT lengths, guard band lengths, and SNR

values. FBMC is considered advantageous in comparison to OFDM by offering higher spectral efficiency. Due to the subcarrier filtering, it incurs a larger filter delay (in comparison to UFMC) and also requires OQAM processing, which requires modifications for MIMO processing.

Furthermore, a unifying cross-layer framework is proposed that encompasses the downlink scheduling and resource allocation procedures and builds upon a model of the queueing process at the data-link control layer and a physical layer abstraction that can be picked to model either OFDM or FBMC. Extensive numerical results conclusively demonstrate that most of the apriori advantages of FBMC over OFDM do indeed translate into improved network indicators, that is, the increase in spectral efficiency achieved by FBMC makes up for the distortion caused by the loss of orthogonality. Nevertheless [69] FBMC is better suited than OFDM in theory, practical reflections pinpoint many issues of FBMC. Therefore, a new waveform called Universal Filtered Multi-Carrier (UFMC) collecting the advantages of FBMC is promising while preventing its setbacks. In contrast to FBMC, UFMC applies a filtering functionality per sub-band instead of per subcarrier.



**Figure 28:** Waveform comparison: synthesis radar chart

L. CHAPTER FIVE – CONCLUSION

LI. CONCLUSION

After analyzing the results obtained in this thesis, it is concluded that fair comparison for several representative criteria involving Spectral Efficiency, PAPR, PSD in relation to the three most promising waveform candidates for 5G are compared extensively. This section has been devoted to the illustration of some of the most promising modulation schemes for use in forthcoming 5G cellular networks. In this study, a fair analysis of several 5G waveform candidates (OFDM, UFMC and FBMC) is projected under a common framework. PSD, SE, PAPR and robustness to asynchronous multi-user UL transmission are assessed. Based on these end results, a bit loading algorithm is proposed to cope with the non-uniform distribution of the interference across the carriers in order to boost the SE. We establish that if an apriori information on the SNR is present, it is possible to highly increase the SE of the transmission. UFMC waveform is an interesting option. The SE is comparable to the one of OFDM and the pulse shaping function gives robustness to access with relax synchronization compared to OFDM. UFMC also preserves backward compatibility with well-known OFDM algorithms (channel estimation, MIMO detectors). On the other hand, the interest of FBMC-QAM is limited, considering actual

literature proposals. However, one can imagine future enhancements in the filter design.

FBMC goes further beyond the norm. The well localized frequency response entitles the use of fragmented spectrum with minor interference on adjacent bands. Marvelous performances are demonstrated in non-synchronous access (whatever the time delay between users). Nonetheless, under the time–frequency localization relationship, the time localization is given up, making this new waveform difficult to adapt to short packet size. It has nevertheless been demonstrated in this paper that increasing the inter carrier spacing could give FBMC very beneficial qualities.

On the other hand, the absence of guard period gives FBMC an efficiency gain for larger packet size or broadcast transmission (in the DL for example). One of the additional challenges FBMC waveform is facing is the adaption to multiple antenna schemes. This issue is not straightforward and concepts have to be revisited. Finally, the intrinsic complexity of the transceiver is greater (it is also true for UFMC) compared to OFDM transceivers. To be at par, FBMC transceiver complexity still needs to be compared with the complexity of an OFDM transceiver with embedded digital or analog filtering functions. In that scenario, when flexibility is required (dynamic spectrum allocation on non-contiguous spectrum), the complexity of FBMC and UFMC transceivers could be few orders of magnitude below. Certainly, performance as well as equalization complexity heavily rely on the type of prototype filter. In this work we limit our comparisons to the PHYDYAS prototype filter.

Optimization depending on the channel as well as comparison of various prototype filter. OFDM is here defined as reference. The benefits of new waveforms for the 5G use cases have been clearly highlighted. UFMC offers improvements, while keeping backward compatibility with legacy OFDM, while FBMC-OQAM goes forward, making this waveform particularly interesting for 5G scenarios. We indeed demonstrated the benefits of the FBMC waveform compared to legacy LTE waveforms and UFMC in terms of PSD, SE, and robustness against both a synchronicity and high delay spread environment. Last but not least, the parametrization of FBMC (with the use of various inter carrier spacing or different overlapping factors) allows better flexibility to cope with various services and scenarios. The study and the implementation of the waveforms shows that clearly UFMC has better performance than OFDM in terms of PAPR, spectral efficiency, inter carrier interference or inter symbol interference. The main advantage of UFMC is the use of Dolph-Chebyshev filter. Truly, according to these filter properties, the spectral OFDM effects of side lobes interference on the immediate adjacent subcarrier can be minimized significantly. By these properties two OFDM issues are answered. The need of a guard band is no longer needed because other UFMC symbols would not be shared by the side lobe interference. Likewise, UFMC is more robust to inter carrier interference and loss of orthogonality can no longer be a problem.

While legacy OFDM is a robust and mature technology used in most communication systems. Certainly, OFDM modulation is the core PHY technology of 4G systems, and is also used in other systems such as digital audio broadcasting and terrestrial digital video broadcasting. The very stringent requirements of future networks, along with the heterogeneous scenarios that they will have to perform in, has pushed researchers to look for other solutions. One conclusion that can surely be drawn is the question of what is the “best” modulation. It is a question that cannot be easily answered, and indeed the right answer might be “it depends”, in the sense that there is no modulation that acts as the best in all available operating conditions. In some cases, UFMC, by virtue of its low side lobe levels, is a modulation scheme that has been designed to perform well in scenarios where asynchronous transmissions and carrier frequency offsets may result to ICI, although this property is retained by FBMC too.

Due to its long shaping filters, FBMC unluckily has a low efficiency in situations where small data packets are to be transmitted, a scenario typical of the IoT. Both UFMC and FBMC do not require the use of a CP, and this is a vivid benefit with respect to filtered-OFDM, for example. The latency requirement also plays a major role and, in this regards, FBMC again appears a weak choice since the long impulse response of its shaping filters forbid its use in situations of sporadic traffic and low latency. Ultimately, the answer to the problem of choosing a recent modulation scheme will reside in the so-called software-defined-networking paradigm. For sure, the

trend that we are witnessing in recent years is the increased role of software implementations with regrades to hardware implementation of communication services. 5G networks will see a lot of functionality implemented via software as well. In addition, PHY-layer functions will be partly virtualized and implemented in a data-center. A virtualized PHY service will allow tuning of the modulation parameters to the scenario at hand; the modulation scheme itself might be changed according to the operating scenario. In this framework, one might figure out a software-defined adaptive PHY, which would absolutely be able to cope with the stringent levels of flexibility, scalability, performance and efficiency that 5G networks will need.

## ACKNOWLEDGEMENT

It gives me immense pleasure to express my heartily gratitude to everyone who supported and guided me in the completion of my thesis. Foremost, I would like to express my sincere gratitude to the Almighty God for giving me life and keeping me through the thick and thin. My college mates. Without their excellent guidance, supervision, encouragement and support, I would have never been able to finish this work. They have been great source of inspiration and I feel extremely fortunate to work with them. I would like to acknowledge my parents, wife and the entire Samuel family for encouraging and supporting me. They have been a source of moral support to me and have extended their helping hands without fail.

## REFERENCES

- [1] T. Specification, G. Radio, A. Network, N. Generation, and A. Technologies, "3gpp tr 38.913 V14.2.0 Study on Scenarios and Requirements for Next Generation Access Technologies;," vol. 0, pp. 0–40, 2017.
- [2] BR, "Recommendation ITU-R M.2083-0 Policy on Intellectual Property Right (IPR) Series of ITU-R Recommendations," vol. 0, 2015.
- [3] Y. Cai, Z. Qin, F. Cui, G. Y. Li, and J. A. McCann, "Modulation and Multiple Access for 5G Networks," *IEEE Commun. Surv. Tutorials*, vol. 20, no. 1, pp. 629–646, 2018.
- [4] E. Ayanoglu, "5G today: Modulation technique alternatives," 2016 Int. Conf. Comput. Netw. Commun. ICNC 2016, 2016.
- [5] M. Agiwal, A. Roy, and N. Saxena, "Next Generation 5G Wireless Networks: A Comprehensive Survey," *IEEE Commun. Surv. Tutorials*, vol. 18, no. 3, pp. 1617–1655, 2016.
- [6] P. Rost et al., "Cloud technologies for flexible 5G radio access networks," *IEEE Commun. Mag.*, vol. 52, no. 5, pp. 68–76, 2014.
- [7] A. Goldsmith, "Wireless Communications," 2005.
- [8] MATLAB, "5G Development with MATLAB," Matlab, 2017.
- [9] A. Zaidi, F. Athley, J. Medbo, U. Gustavsson, G. Durisi, and X. Chen, "Introduction: 5G Radio Access," *5G Phys. Layer*, pp. 1–19, 2018.
- [10] A. Zaidi, F. Athley, J. Medbo, U. Gustavsson, G. Durisi, and X. Chen, "NR Physical Layer: Overview," *5G Phys. Layer*, pp. 21–34, 2018.
- [11] J. Yli-Kaakinen et al., "Efficient fast-convolution-based waveform processing for 5G physical layer," *IEEE J. Sel. Areas Commun.*, vol. 35, no. 6, pp. 1309–1326, 2017.
- [12] P. Banelli, S. Buzzi, G. Colavolpe, A. Modenini, F. Rusek, and A. Ugolini, "5G Networks : Who Will," no. november, pp. 80–93, 2014.
- [13] C. Bartlett, S. Wong, P. Péladeau, A. Macpherson, and M. Lawley, "Making 5G pay."
- [14] J. Yli-Kaakinen et al., "Efficient fast-convolution-based waveform processing for 5G physical layer," *IEEE J. Sel. Areas Commun.*, 2017.
- [15] Z. Ma, Z. Zhang, Z. Ding, P. Fan, and H. Li, "Key techniques for 5G wireless communications: network architecture, physical layer, and MAC layer perspectives," *Sci. China Inf. Sci.*, vol. 58, no. 4, pp. 1–20, 2015.
- [16] R. Gerzaguët, D. Ktésnas, N. Cassiau, and J.-B. Doré, "Comparative study of 5G waveform candidates for below 6GHz air interface," *ETSI Work. Futur. Radio Technol. Air Interfaces*, pp. 1–9, 2016.
- [17] Y. Qi and M. Al-Imari, "An enabling waveform for 5G - QAM-FBMC: Initial analysis," 2016 IEEE Conf. Stand. Commun. Networking, CSCN 2016, 2016.
- [18] M. Yang et al., "Cross-Layer Software-Defined 5G Network," *Mob. Networks Appl.*, vol. 20, no. 3, pp. 400–409, 2015.
- [19] P. F. Pazos, "Waveform evaluation for 5G Networks," 2015.
- [20] Y. W. Learn, "Understanding the 5G NR Physical Layer," 2017.
- [21] J. B. Doré, R. Gerzaguët, N. Cassiau, and D. Ktenas, "Waveform contenders for 5G: Description, analysis and comparison," *Phys. Commun.*, vol. 24, pp. 46–

- 61, 2017.
- [22] A. Iqbal, S. Shah, and M. Amir, "Adaptive Investigating Universal Filtered Multi-Carrier (UFMC) Performance Analysis in 5G Cognitive Radio Based Sensor Network (CSNs)," *Int. J. Eng. Work. Kambohwel Publ. Enterp. ISSN*, vol. 4, no. 1, pp. 5–9, 2017.
- [23] J. Abdoli, M. Jia, and J. Ma, "Filtered OFDM: A new waveform for future wireless systems," *IEEE Work. Signal Process. Adv. Wirel. Commun. SPAWC*, vol. 2015-Augus, pp. 66–70, 2015.
- [24] F. Schaich, T. Wild, and Y. Chen, "Waveform contenders for 5G - Suitability for short packet and low latency transmissions," *IEEE Veh. Technol. Conf.*, vol. 2015-Janua, no. January, 2014.
- [25] T. L. Marzetta, "Noncooperative Cellular Wireless with Unlimited Numbers of Base Station Antennas," vol. 9, no. 11, pp. 1–4, 2010.
- [26] W. H. Chin, Z. Fan, and R. Haines, "Emerging technologies and research challenges for 5G wireless networks," *IEEE Wirel. Commun.*, vol. 21, no. 2, pp. 106–112, 2014.
- [27] M. Boban, K. Manolakis, M. Ibrahim, S. Bazzi, and W. Xu, "Design aspects for 5G V2X physical layer," 2016 IEEE Conf. Stand. Commun. Networking, CSCN 2016, 2016.
- [28] G. Femenias, F. Riera-Palou, X. Mestre, and J. J. Olmos, "Downlink scheduling and resource allocation for 5G MIMO-multicarrier: OFDM vs FBMC/OQAM," *IEEE Access*, vol. 5, no. c, pp. 13770–13786, 2017.
- [29] B. T. S. Rappaport, S. Su, and S. Member, "5G Channel Model with Improved Accuracy and Efficiency in mmWave Bands," *IEEE 5G Tech Focus*, vol. 1, no. 1, pp. 25–26, 2017.
- [30] M. Meraj and S. Kumar, "Evolution of Mobile Generation Technology: 1G To 5G and Review of Upcoming Wireless Technology 5G," *Int. J. Comput. Sci. Inf. Technol.*, vol. 6, no. 3, pp. 2545–2551, 2015.
- [31] F. Boccardi, R. Heath, A. Lozano, T. L. Marzetta, and P. Popovski, "Five disruptive technology directions for 5G," *IEEE Commun. Mag.*, 2014.
- [32] P. Taylor, S. N. Dorogovtsev, and J. F. F. Mendes, "Advances in Physics Evolution of networks," *Adv. Phys.*, no. November 2011, pp. 37–41, 2010.
- [33] N. Michailow, R. Datta, S. Krone, M. Lentmaier, and G. Fettweis, "Generalized Frequency Division Multiplexing : A Flexible Multi-Carrier Modulation Scheme for 5th Generation Cellular Networks," *IEEE Trans. Commun.*, vol. 62, no. 9, pp. 3045–3060, 2012.
- [34] G. Yasin et al., "Exploring the Nickel–Graphene Nanocomposite Coatings for Superior Corrosion Resistance: Manipulating the Effect of Deposition Current Density on its Morphology, Mechanical Properties, and Erosion-Corrosion Performance," *Adv. Eng. Mater.*, vol. 20, no. 7, 2018.
- [35] N. Kaur and L. Kansal, "Comprehensive study of future waveforms for 5G," no. July, 2018.
- [36] S. Han, I. Chih-Lin, G. Li, S. Wang, and Q. Sun, "Big Data Enabled Mobile Network Design for 5G and beyond," *IEEE Commun. Mag.*, vol. 55, no. 9, pp. 150–157, 2017.
- [37] D. (IEEE) Soldani, "future networks:Enabling 5G and beyond." 2019.
- [38] W. Paper, MATLAB, and W. Paper, "Hybrid Beamforming for Massive MIMO Phased Array Systems," no. May, p. 22, 2017.
- [39] I. Qualcomm Technologies, "Making 5G NR a reality," no. December, 2016.
- [40] S. Zhang, X. Xu, L. Lu, Y. Wu, G. He, and Y. Chen, "Sparse code multiple access: An energy efficient uplink approach for 5G wireless systems," 2014 IEEE Glob. Commun. Conf. GLOBECOM 2014, pp. 4782–4787, 2014.
- [41] J. B. Dore, R. Gerzaguet, and D. Ktenas, "5G cellular networks with relaxed synchronization: Waveform comparison and new results," in *IEEE Vehicular Technology Conference*, 2016.
- [42] A. F. Demir, M. H. Elkourdi, M. Ibrahim, and H. Arslan, "Waveform design for 5G and beyond," *5G Networks Fundam. Requir. Enabling Technol. Oper. Manag.*, no. September, pp. 51–76, 2018.
- [43] R. Kaur, N. Kaur, L. Kansal, G. S. Gaba, and M. Baz, "A study of diverse waveforms for 5G," *Int. J. Pure Appl. Math.*, vol. 118, no. Special Issue 9, 2018.
- [44] P. X. and R. T. Ayesha Ijaz, Lei Zhang, "Analysis of Candidate Waveforms for 5G Cellular Systems," *Intech*, vol. i, no. tourism, p. 13, 2016.
- [45] G. Berardinelli, K. Pajukoski, E. Lähetkangas, R. Wichman, O. Tirkkonen, and P. Mogensen, "On the potential of OFDM enhancements as 5G waveforms," *IEEE Veh. Technol. Conf.*, vol. 2015-Janua, no. January, 2014.
- [46] N. K.P and C. Kiran, "Studying Applicability Feasibility of OFDM in Upcoming 5G Network," *Int. J. Adv. Comput. Sci. Appl.*, vol. 8, no. 1, pp. 216–226, 2017.
- [47] K. Fazel and S. Kaiser, *Multi-Carrier and Spread Spectrum Systems*. 2008.
- [48] H. Lin and P. Siohan, "Multi-carrier modulation analysis and WCP-COQAM proposal," *EURASIP J. Adv. Signal Process.*, 2014.
- [49] A. R. S. Bahai, B. R. Saltzberg, and M. Ergen, *Multi-Carrier Digital Communications: Theory and Applications of OFDM*. 2004.
- [50] R. S. Propagation and J. Articles, "Radio - Radio Signal Propagation," pp. 5–7, 2018.
- [51] C. Bockelmann et al., "Massive machine-type communications in 5g: Physical and MAC-layer solutions," *IEEE Commun. Mag.*, vol. 54, no. 9, pp. 59–65, 2016.
- [52] "Beamforming for MIMO-OFDM Systems.pdf" .

- [53] M. V. Paolo Prandoni, 信号源推定 Signal Processing for Communication. 2008.
- [54] S. Chang, W. Hong, and J. Oh, "Quantization effects of phase shifters on 5G mmWave antenna arrays," in IEEE Antennas and Propagation Society, AP-S International Symposium (Digest), 2015.
- [55] G. Matz and F. Hlawatsch, "Time-Frequency Foundations of Communications," IEEE Signal Process. Mag., no. November, pp. 87–96, 2013.
- [56] B. Farhang-boroujeny, "Fbmc Ofdm," no. April 2011, pp. 92–112.
- [57] R. Gerzaguet et al., "The 5G candidate waveform race: a comparison of complexity and performance," EURASIP J. Wirel. Commun. Netw., vol. 2017, no. 1, p. 13, 2017.
- [58] S. J. Darak and S. Garg, "Candidate waveforms for wireless communications: analysis via hardware software co-design on Zynq SoC," 2017.
- [59] Z. E. Ankarali, "Physical Layer Algorithms for Reliability and Spectral Efficiency in Wireless Communications," no. November, 2017.
- [60] A. A. Zaidi et al., "Waveform and Numerology to Support 5G Services and Requirements," IEEE Commun. Mag., vol. 54, no. 11, pp. 90–98, 2016.
- [61] I. 1994-2019 The MathWorks, "F-OFDM VS OFDM.pdf."
- [62] P. L. Yu, J. S. Baras, and B. M. Sadler, "Physical-layer authentication," IEEE Trans. Inf. Forensics Secur., vol. 3, no. 1, pp. 38–51, 2008.
- [63] I. The MathWorks, "UFMC vs. OFDM Modulation.pdf."
- [64] I. C. At and I. O. N. No, "Solutions for Design and Evaluation of 5G Candidate Waveforms."
- [65] H. Bogucka, "Advanced Multicarrier Technologies for 5G and Beyond," 2017.
- [66] F. Luo, "Modulation , Coding and Waveform for 5G."
- [67] P. Naga Rani and C. H. Santhi Rani, "UFMC: The 5G modulation technique," in 2016 IEEE International Conference on Computational Intelligence and Computing Research, ICCIC 2016, 2017.
- [68] M. Schellmann et al., "FBMC-based air interface for 5G Mobile: Challenges and proposed solutions," 2014.
- [69] F. Schaich and T. Wild, "Waveform contenders for 5G - OFDM vs. FBMC vs. UFMC," ISCCSP 2014 - 2014 6th Int. Symp. Commun. Control Signal Process. Proc., pp. 457–460, 2014.
- [70] P. Naga Rani and C. H. Santhi Rani, "UFMC: The 5G modulation technique," 2016 IEEE Int. Conf. Comput. Intell. Comput. Res. ICCIC 2016, 2017.
- [71] X. Li, R. Salleh, A. Aani, and O. Zakaria, "Multi-network data path for 5G mobile multimedia," in Proceedings of the 2009 International Conference on Communication Software and Networks, ICCSN 2009, 2009.
- [72] U. Siddique, H. Tabassum, and E. Hossain, "Spectrum allocation for wireless backhauling of 5G small cells," in 2016 IEEE International Conference on Communications Workshops, ICC 2016, 2016.
- [73] S. Nagul, "A review on 5G modulation schemes and their comparisons for future wireless communications," in 2018 Conference on Signal Processing And Communication Engineering Systems, SPACES 2018, 2018.

## Authors

**Samuel Acquah** - received the BSc degree in Electronics & Communications Engineering from All Nations' University College, Ghana and MSc degree in Information Communication Engineering from Jiangsu University of Science and Technology, China in 2017 and 2019 respectively. He is currently a research fellow at Shanghai University, China. His current research interest include telecommunications and network optimizations, localization and target tracking, system reliability.

**Anastasia Krampah-Nkoom** – received the BA degree in publishing studies from Kwame Nkrumah University of Science and Technology, Ghana and MA degree in Business Administration from Jiangsu University, China in 2016 and 2019 correspondingly. She is currently a research fellow at Jiangsu University, China. Her research interest include Online Training, Information Management, Employee self – Efficacy and School Management. ([Anastasiankoom2011@gmail.com](mailto:Anastasiankoom2011@gmail.com))

**Mark Owusu Adjei** – received the BSc degree in Animal Science from University for Development Studies, Ghana and MSc degree in Special Economic in Animal Rearing from Jiangsu University of Science and Technology China, in 2015 and 2019 respectively. He is currently pursuing his PhD in Plant Microbiology with Sichuan Agricultural University. His current research interest include gene function and expression.

([mowusuadjei@gmail.com](mailto:mowusuadjei@gmail.com))

**Correspondence author-** Samuel Acquah: [oforituga@hotmail.com](mailto:oforituga@hotmail.com), +233554136348