

Interplay Between NOMA and Other Emerging Technologies: A Survey

Mojtaba Vaezi, *Senior Member, IEEE*, Gayan Amarasuriya, *Member, IEEE*, Yuanwei Liu, *Member, IEEE*, Ahmed Arafa, *Member, IEEE*, Fang Fang, *Member, IEEE*, and Zhiguo Ding, *Senior Member, IEEE*
(Invited Paper)

Abstract—Non-orthogonal multiple access (NOMA) has been widely recognized as a promising way to scale up the number of users, enhance the spectral efficiency, and improve the user-fairness in wireless networks, by allowing more than one user to share one wireless resource. NOMA can be flexibly combined with many existing wireless technologies and emerging ones including multiple-input multiple-output (MIMO), massive MIMO, millimeter wave communications, cognitive and cooperative communications, visible light communications, physical layer security, energy harvesting, wireless caching, and so on. Combination of NOMA with these technologies can further increase scalability, spectral efficiency, energy efficiency, and greenness of future communication networks. This paper provides a comprehensive survey of the interplay between NOMA and the above technologies. The emphasis is on how the above techniques can benefit from NOMA and vice versa. Moreover, challenges and future research directions are identified.

Index Terms—NOMA, massive MIMO, mmWave, cooperative communications, cognitive radio, energy harvesting, mobile edge computing, physical layer security, visible light communications, machine learning, deep learning, 5G.

I. INTRODUCTION

Multiple access techniques allow multiple users to share the same communication resource and are instrumental in making cellular communication work [1]. The first to the fourth generation (1G to 4G) cellular networks are distinguished by their multiple access methods, yet these radio access methods have been developed with one common concept: to *orthogonalize* the signal of different users by allocating distinct resources (be it frequency, time, code, or space) to different users. The orthogonalization of the wireless resources simplifies the receiver design since it prevents inter-user interference. Such access methods are not, however, optimal theoretically. More

importantly, they restrict the numbers of users to the number of orthogonal resources.

Fifth generation (5G) wireless networks must support a large number of connections with diverse requirements in terms of throughput and latency. The need for massive connectivity in 5G networks and beyond is mainly pushed by the proliferation of the Internet of things (IoT) devices, which is projected to have 20% to 30% annual growth in the next several years. In view of such projections, the 5G performance requirements set by the international telecommunication union (ITU) for IMT-2020 requires 100 times more connection density than that in 4G.

In order to fulfill the diverse requirements of 5G and beyond cellular networks, several new technologies have been developed during the past decade. Among them is *non-orthogonal multiple access* (NOMA) [1]–[3], which can help to address the above challenges more efficiently than the conventional orthogonal multiple access (OMA) schemes. NOMA can be flexibly combined with many other existing and emerging technologies, such as multiple-input multiple-output (MIMO) and massive MIMO, millimeter wave, cognitive and cooperative communications, physical layer security, visible light communications, energy harvesting, mobile edge computing, etc. NOMA can be combined with these technologies to further increase the number of users and enhance the system performance in various senses.

This survey paper reviews the contributions that combine NOMA with the above-mentioned technologies with an emphasis on how these technologies interplay and benefit from each other. To better understand these relations, we first briefly explain the salient features of each technology in the following.

A. Non-orthogonal Multiple Access (NOMA)

By allowing multiple users to simultaneously access the same wireless resources, NOMA offers a promising solution to the need for massive connectivity in 5G and beyond. This term was coined by Saito *et al.* [2], where the authors showed that simultaneous transmission of users' signal can improve system throughput and user-fairness over a single-input single-output (SISO) channel when using orthogonal frequency-division multiple access (OFDMA). In theory, however, since several decades ago, it has been known that concurrent (non-orthogonal) transmission of users messages is the optimal transmission strategy. In fact, to achieve the capacity region

M. Vaezi is with the Department of Electrical and Computer Engineering, Villanova University, Villanova, PA, USA (e-mail: mvaezi@villanova.edu).

G. Amarasuriya is with the Department of Electrical and Computer Engineering, Southern Illinois University, Carbondale, IL, USA 62901 (email: gayan.baduge@siu.edu).

Y. Liu is with School of Electronic Engineering and Computer Science, Queen Mary University of London, London E1 4NS, U.K. (e-mail: yuanwei.liu@qmul.ac.uk).

A. Arafa is with the Department of Electrical and Computer Engineering, University of North Carolina Charlotte, NC, USA (e-mail: aarafa@uncc.edu).

F. Fang and Z. Ding are with the School of Electrical and Electronic Engineering, the University of Manchester, Manchester M13 9PL, U.K. (email: {fang.fang.zhiguo.ding}@manchester.ac.uk).

The work of Z. Ding was supported by the UK EPSRC under grant number EP/P009719/2 and by H2020-MSCA-RISE-2015 under grant number 690750.

TABLE I
THE ORGANIZATION OF THE PAPER

Organization	Technology combined with NOMA	Figures	Tables
Section II	Massive MIMO	Fig. 1	Table II
Section III	mmWave communications		Table III
Section IV	Cooperative communications		Table IV
Section V	Cognitive communications	Fig. 2	
Section VI	Physical layer security	Fig. 3	Table V
Section VII	Energy harvesting	Fig. 4 and Fig. 5	Table VI
Section VIII	Visible light communications	Fig. 6	Table VII
Section IX	Mobile edge computing	Fig. 7	Table VIII

of the downlink transmission in a single-cell wireless networks, modeled by the *broadcast channel* (BC), the users must transmit at the same time and frequency [4]–[6]. The capacity region of this channel is achieved using *superposition coding* at the base station (BS). For decoding, the user with a stronger channel gain (typically the one closer to the BS) uses *successive interference cancellation* (SIC) to decode its signal free of interference, while the user with weaker channel gain treats the signals of the stronger users as noise. Despite its well-established theory, NOMA community has been prone to several myths and misunderstandings [10].

Today, NOMA is actively being investigated by academia, standardization bodies, and industry [11]. This owes, partly, to the advances in processing power which make interference cancellation at user equipment viable. It is also pushed by the need for massive connectivity and better spectral efficiency. The successful operation of this technique, however, depends on knowledge of the channel state information (CSI) at the BS and end users. While recent advances in processor capabilities have made SIC, and consequently NOMA, feasible, significant research challenges remain to be addressed before NOMA can be deployed commercially.

B. Other Emerging Technologies

1) *Massive MIMO*: Massive MIMO can drastically increase the spectral efficiency of wireless networks via aggressive spatial multiplexing [12]–[15]. Massive MIMO has extensively been studied with OMA, and it is known that, with the prevalent linear processing at the BS, the best spectral efficiency of massive MIMO-OMA systems is obtained in *underloaded* systems. Specifically, for the maximum ratio (MR) combining and zero-forcing (ZF) combining, the highest spectral efficiency is achieved when the number of users is about 2 and 5 times less than the number of antennas [16]. Therefore, massive MIMO-OMA may not be able to support the *overloaded* systems, i.e., when the number of users exceeds the number of antennas at the BS. Massive MIMO-NOMA, on the other hand, has a great potential to overcome this limit and to support massive connectivity requirements of the next-generation wireless networks while further improving the spectral efficiency of NOMA-based systems [17]. We further investigate these potentials in Section II.

Similarly, to obtain the highest achievable region in the multi-cell systems, concurrent non-orthogonal transmission is required [5]–[9], and orthogonal transmission is suboptimal.

2) *Millimeter wave communications*: To fulfill extremely high data rate requirements of next-generation wireless networks, the communication at millimeter wave (mmWave) bands (30 GHz to 300 GHz spectrum) has been subject to intensive research during the past decade, and it has been proven theoretically and experimentally to provide gigabit-per-second data rates due to huge available bandwidths (e.g. up to 2 GHz bandwidth in 60 GHz) [18], [19]. However, since mmWave channels are sparse in spatial/angle domain, the number of simultaneous connections at these very high frequencies has shown to be limited. Coupled with mmWave massive MIMO, NOMA can circumvent this limit. Section III details this by summarizing the state-of-the-art on the coexistence of NOMA and mmWave massive MIMO.

3) *Cooperative communications*: Cooperative communications has great potential to improve wireless networks throughput and is a well-investigated area of research. The key idea of cooperation is to share resources among multiple nodes in a network. With user-cooperation, e.g., sharing power and computation with certain nodes, overall network performance can be improved. Include these two references [20], [21]. Different relaying schemes, device-to-device communication, and multi-cell cooperative transmission are among the well-known operative scheme. NOMA and cooperative communications are capable of mutually supporting each other. Particularly, relay-aided NOMA and multi-cell cooperation have recently attracted considerable attention, for their great promise in improving spectral efficiency and user fairness. These schemes will be discussed in Section IV.

4) *Cognitive communications*: Cognitive radio (CR) networks exploit spectrum sharing to improve spectral efficiency [22]. Overlay CR is to employ unused spectrum and is usually performed opportunistically but CRs can work concurrently with incumbent users. CRs sense spectrum, detect incumbent users, and efficiently allocate/use spectrum. Similar to cooperative communications, cognitive communications promises great potential for spectral efficiency and has been under investigation for more than two decades. NOMA can be applied to CR networks to increase the number of users and further increase the spectral efficiency. On the other hand, the principle of underlay CR can be utilized to design the so-called CR-inspire NOMA. The interplay between CR and NOMA will be discussed in Section V.

5) *PHY security*: Physical layer (PHY) security is a means of complementing higher-layer cryptographic security measures in wireless networks. Unlike cryptographic approaches,

PHY security approaches can guarantee information secrecy regardless of an eavesdropper's computational capability. PHY security techniques exploit the physical characteristics of the wireless communication channel, e.g., *noise*, *fading*, and *interference*, to guarantee secure communication directly at the physical layer. These approaches aim at degrading the quality of signal reception at eavesdroppers compared to the main channel and thereby preventing them from decoding the confidential information from the intercepted signals [23]–[26]. NOMA-based systems are susceptible to eavesdroppers and can benefit from PHY security as we elaborate this in Section VI.

6) *Energy harvesting*: Energy harvesting communications offer the promise of providing energy self-sufficient and self-sustaining means of communications; a step toward realizing *green* communications [27]. While energy is usually harvested from external natural sources, it could also be harvested from ambient radio frequency (RF) electromagnetic signals. The notions of simultaneous wireless and information power transfer (SWIPT) and wireless-powered communication networks (WPCN) are introduced and thoroughly studied in recent literature for that purpose. In SWIPT, energy is provided *along the way* during information transmission, in which users either employ power switching or time switching techniques to harvest energy (partially) from the transmitted signals. While in WPCN, energy is transferred wirelessly toward intended users so that they use it, mainly, to communicate back to the energy-providing sources. It is clear that such notions offer great potential to enhance different NOMA performance metrics, such as energy efficiency, achievable rates, and outage probabilities. We elaborate on this further in Section VII.

7) *Visible light communications (VLC)*: VLC presents solutions to spectrum congestion and scarcity issues, especially in indoor environments, through shifting transmission frequencies from conventional RF ranges to the visible light range [28]. As such, transmit antennas become light emitting diodes (LEDs) and receive antennas become photodetectors (PDs). VLC is the enabling technology behind realizing light fidelity (LiFi) networks, and lots of research are currently being conducted to improve the performance of VLC. It is therefore amenable to combine VLC with NOMA techniques in multiuser scenarios to provide an efficient way to handle the available resources. We discuss this idea further in Section VIII.

8) *Mobile edge computing (MEC)*: MEC has emerged as a means of providing remote computation for mobile devices in 5G wireless systems and is driven by the increasing demand for traffic volume and computation raised by the emerging compute-intensive applications, e.g., virtual reality and interactive gaming [29]. Due to their low computing capability, mobile devices can offload their tasks to the BSs equipped with an MEC server. The offloaded tasks will be executed by the MEC server, and the result will be downloaded to the mobile devices after computing. In the MEC system, there are two offloading scenarios, i.e., *partial* offloading and *binary* offloading. In the partial offloading, the task can be partitioned into two main parts, i.e., offloading part and local computing part. In the binary offloading scheme, the task cannot be

partitioned. It means each task will be either offloaded to the MEC server for remote execution or locally computed by the mobile devices.

C. Organization and Existing Survey Papers

As summarized in Table. I, the remainder of this paper is organized as follows. In Sections II and III, the coexistence of NOMA with massive MIMO and mmWave massive MIMO is described, respectively. Sections IV and V elaborate on interaction of NOMA with cooperative and cognitive communications, respectively. PHY security approaches enabling the exchange of confidential messages over NOMA-based networks in the presence of in network and external eavesdroppers are described in Section VI. The state-of-the-art in the burgeoning area of energy harvesting NOMA are detailed in Section VII. Section VIII discusses combining NOMA with VLC and the effect of that on more efficient resource management. Section IX highlights possible application of NOMA to the emerging area of mobile edge computing. Finally, Section X briefly lists other technologies benefiting from NOMA as well as applications of machine learning and deep learning in solving different problems in NOMA, including clustering and power allocation. Section XI concludes the paper.

There exist a number of interesting survey papers in this topic [30]–[33]. This survey paper is different from the existing ones in that we are specifically focusing on the contributions that combine NOMA with the emerging technologies listed in Section I-B and emphasis how NOMA and these prominent technologies interplay with, benefit from, and shape the future of research in wireless networks. Further, this paper includes recent progresses reported in recently-published works that have not been included in previous surveys.

II. COEXISTENCE OF NOMA AND SUB-6 GHz MASSIVE MIMO

Massive MIMO systems operating in sub-6 GHz frequency bands primarily rely on substantial spatial multiplexing gains and favorable propagation characteristics rendered by very large antenna arrays to simultaneously serve many user nodes in the same time-frequency resource element [12]. Sub-6 GHz massive MIMO has been shown to provide unprecedented spectral/energy efficiency gains [13]–[15], and it has already been deployed by commercial carriers such as Sprint in the United States [34]. Despite these benefits, massive MIMO with OMA may not be able to support the overloaded case in which the number of user nodes exceeds the number of RF chains at the BS. Hence, sub-6 GHz massive MIMO with OMA may not be able to support the massive connectivity requirement of the next-generation wireless standards. To this end, joint benefits of NOMA and sub-6 GHz massive MIMO can be efficiently leveraged to satisfy future demands for massive wireless connectivity with high data rates and low-latency [17], [35]–[49].

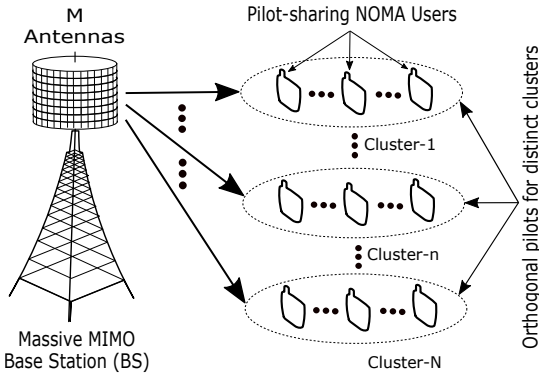

Fig. 1. A system model for massive MIMO-NOMA with non-orthogonal pilot allocation within clusters [35], [36].

TABLE II
SUMMARY OF TECHNICAL CONTRIBUTIONS ON NOMA-ENABLED MASSIVE MIMO OPERATING IN SUB-6 GHz

References	Technical contribution
[17], [36]	Impact of estimated CSI on the performance bounds of single-cell systems with linear precoders
[35], [37], [42]	Pilot allocation strategies for multi/single-cell systems
[46]	Performance bounds for uplink superposition coded NOMA transmissions
[37], [38]	User pairing/grouping and scheduling techniques and underlying performance bounds
[39], [40]	Iterative signal decoding algorithms for superposition-coded transmissions
[37], [41]	Transmit power allocation techniques and performance comparisons
[43]–[45]	Effects of distributed massive antenna systems on the performance bounds
[41], [47], [50]–[52]	Integration of relaying techniques and performance analysis
[49]	Integration with underlay spectrum sharing techniques

A. Design Insights and Implications

In this subsection, we summarize key design insights, implications of practical transmission impairments, and concluding remarks for sub-6 GHz massive MIMO-NOMA systems.

The importance of acquisition of accurate CSI for integrating NOMA into massive MIMO has been elaborated in [17], [35]–[37]. The performance metrics derived by assuming the genie-aided perfect CSI can be misleading in a practical massive MIMO set-up because they always overestimate the system performance. To this end, in [35], [36], it has been revealed that in an overloaded NOMA system, the achievable performance is always detrimentally affected by residual interference caused by intra/inter-cluster pilot contamination even in the asymptotic BS antenna regime.

In [36], the performance of NOMA has been compared against the conventional multi-user spatial multiplexing with OMA for a training-based sub-6 GHz massive MIMO system by adopting a non-orthogonal pilot allocation (see Fig. 1). Reference [35] extends the system model and performance analysis of [36] to facilitate multiple cells. It has been shown in [36] that NOMA outperforms OMA in terms of the achievable

sum rate only when all user nodes are provided with highly accurate estimated CSI through beamforming downlink pilots and with no inter-cluster interference. The performance gains of NOMA over OMA can be boosted when there exist distinct path-losses of the channels pertaining to user nodes located within the same cluster. Moreover, [36] advocates OMA with multiuser spatial multiplexing instead of NOMA when there is more than one NOMA user-cluster. It also reveals the importance of accurate estimated CSI at both the BS and user nodes through uplink and downlink pilots transmissions, respectively. The aforementioned conclusions have been drawn in [36] for maximal ratio transmission based precoders at the BS.

In [17], the performance gains that NOMA can provide in a sub-6 GHz massive MIMO system have been investigated. The achievable rate analysis of [17] reveals that massive MIMO-OMA with ZF precoding outperforms power-domain NOMA when the number of antennas at the BS significantly exceeds the number of user nodes ($M \gg K$). Nevertheless, it has also been shown that NOMA performs better than multi-user massive MIMO when the number of BS antennas and total user count are approximately equal ($M \approx K$). Moreover, the performance of massive MIMO-NOMA for a non-line-of-sight (NLoS) independent and identically distributed (i.i.d.) Rayleigh fading channel model has been compared against a line-of-sight (LoS) deterministic channel model. It reveals that the performance gains of NOMA become more prominent for the latter channel model than the former counterpart.

In [37], the achievable performance gains of NOMA over OMA have been compared for a multi-cell massive MIMO system operating over spatially-correlated fading channels. The paper proposes a novel user classification/clustering and pilot allocation schemes based on the channel covariance information. It has been shown that the proposed pilot allocation in [37] outperforms the conventional non-orthogonal pilot allocation of [35], [36] and the orthogonal pilot allocation of [42] in terms of the achievable user rates. Moreover, [37] reveals that the asymptotic achievable rates are no longer limited by the residual intra/inter-cell/cluster interference for the underloaded NOMA case in which the number of BS antennas exceeds the number of user nodes. Nonetheless, the performance gains will be degraded by intra-cluster pilot contamination when the covariance matrices of multiple user nodes located within the same cluster are linearly dependent in the asymptotic BS antenna regime. However, this condition rarely occurs in practice with sub-6 GHz frequency band as the covariance matrices will more likely to be asymptotically linearly independent [53] when the number of antennas at the BS grows without a bound.

The uplink specific transmission designs and performance analysis for NOMA-aided sub-6 GHz massive MIMO have been investigated in [46]. Upon deriving the achievable uplink rates under estimated uplink CSI at the BS, it has been shown in [46] that proper transmit power control at the user nodes is an essential design aspect to boost the achievable uplink rates of massive MIMO-NOMA. When no downlink pilots are transmitted, the user nodes must rely on statistical channel knowledge to implement transmit power control. To

this end, [46] proposes a max-min optimal uplink transmit power control policy based on channel statistics to guarantee user-fairness in the presence of near-far effects in the uplink massive MIMO channels.

B. Applications of Massive MIMO-NOMA in Relay Networks

In [41], [44], [47], [50], [51], the coexistence of sub-6 GHz massive MIMO-NOMA with relay networks has been investigated. By invoking the deterministic-equivalent techniques from random matrix theory, reference [50] investigates the achievable rate bounds for massive MIMO-NOMA relay networks. It has been shown that the achievable sum rate increases linearly with the number of admitted relayed-users, while the ratio between the transmit antenna count and the relay count plays a key role in boosting the system-wide performance metrics. Reference [41] reveals that efficient three dimensional (3D) resource allocation techniques can further improve the performance of NOMA-aided massive MIMO relaying. In [51], the effects of system parameters on the achievable spectral efficiency gains of massive MIMO-NOMA relaying have been investigated for three cases, namely (i) a large number of BS antennas, (ii) a large number of relay nodes, and (iii) a high level of BS transmit power. Moreover, [51] reveals the importance of efficient transmit power optimization at the BS and relay nodes. In [52], the detrimental impact of practical transmission impairments such as the channel estimation errors, pilot contamination, imperfect SIC, intra/inter-cluster interference has been quantified for the relay-aided massive MIMO-NOMA downlink. In [47], for a K -user massive MIMO multi-way relaying, a novel NOMA transmission strategy, which can reduce the number of channel-uses to just two from $\lceil (K-1)/2 \rceil + 1$ in the current state-of-the-art [54], has been investigated.

C. Massive MIMO-NOMA with Distributed Transmissions

The feasibility of massive-scale distributed transmission to boost the performance of NOMA has been investigated in [43]–[45]. To this end, in [43], the achievable downlink rates of a NOMA-aided cell-free massive MIMO system have been derived in the presence of beamforming uncertainty and residual interference due to erroneous channel estimation and imperfect SIC operations. Reference [44] extends the single-antenna access-points (APs) of [43] to support multi-antenna APs in an attempt to leverage the benefits of distributed multi-antenna transmissions to boost the achievable rate performance of the NOMA downlink. Moreover, [49] implements a cell-free version of the underlay spectrum-sharing massive MIMO-NOMA of [48] to ensure that user-centric distributed transmissions improve the performance of secondary underlay spectrum-sharing without hindering the primary system performance gains. A summary of main contributions on massive MIMO-NOMA operating in sub-6 GHz is listed in Table. II.

III. COEXISTENCE OF NOMA AND MMWAVE MASSIVE MIMO

The feasibility of supporting gigabits-per-second data rates by wireless communications at mmWave bands (30 GHz to

TABLE III
SUMMARY OF TECHNICAL CONTRIBUTIONS ON NOMA-ENABLED MASSIVE MIMO OPERATING AT MMWAVES

References	Technical contribution
[63]	Achievable rates and capacity bounds via deterministic equivalent technique
[64]	Limited feedback technique and corresponding performance comparisons
[65]	Finite resolution analog beamforming techniques and performance bounds
[66]	Impact of beam misalignment in hybrid beamforming
[61]	Integration of beamspace techniques with lens antenna arrays
[68], [69]	Multi-beam techniques and beamwidth control algorithms

300 GHz) has been verified both theoretically and experimentally [18], [19], [55], [56]. The large path-losses encountered at these mmWave frequencies can be compensated by leveraging the unprecedentedly high array gains that can be obtained by densely packing a massive number of antennas in a very-small area thanks to much smaller wavelengths of mmWaves [18], [19], [55], [56]. In order to make massive MIMO at mmWaves practically feasible, hybrid beamforming, which cascades a high-dimensional analog-precoder with a low-dimensional digital precoder, is preferred over full-dimensional digital beamforming [57]–[60]. Due to the sparsity of mmWave channels in spatial/angle domain, the number of simultaneous connections that can be by virtue of massive MIMO operating at these very high frequencies has shown to be limited [61], [62]. To circumvent this issue, NOMA can be coupled with mmWave massive MIMO to drastically increase the number of simultaneously served user nodes in the same time-frequency resource element [61]–[67]. A list of important contributions of mmWave massive MIMO-NOMA can be found in Table. III.

A. Design Insights and Implications

In this subsection, we summarize notable contributions to the development of mmWave massive MIMO-NOMA systems. Moreover, the corresponding key design insights, implications of practical transmission impairments, and conclusions are summarized.

The achievable rate bounds of mmWave massive MIMO-NOMA systems have been derived in [63], and thereby, it has been concluded that a combination of massive MIMO with NOMA and mmWaves can provide very large spectral efficiency gains. The achievable rates have been computed for two signal-to-noise ratio (SNR) regimes. By invoking the deterministic equivalent technique with the Stieltjes-Shannon transform, the rate bounds have been established for the noise-dominated low SNR regime. In the interference-limited high SINR regime, the corresponding rate bounds have been derived by using the channel statistics and eigenvalue distributions. These achievable rate bounds may be useful as benchmarks for comparison purposes of practically-viable mmWave massive MIMO-NOMA designs with estimated CSI, imperfect SIC, and residual inter/intra-cell interference.

Reference [64] proposes a low-feedback NOMA design, which decomposes the massive MIMO-NOMA channel into a set of SISO-NOMA channels and thereby significantly reduces the computational complexity. By invoking perfect user-ordering and one-bit feedback, a performance analysis framework has been developed. Thereby, the proposed system model in [64] strikes a balance between the achievable performance gains and the implementation/computational complexity.

Full CSI acquisition and feedback may be prohibitively complicated for analog precoding based mmWave massive MIMO [18], [57]. To this end, finite-resolution analog precoder designs have been adopted to substantially reduce the hardware cost [18]. Consequently, the utilization of such finite-resolution precoders results in mismatches of beam alignments, which in turn yield received power leakages. While imperfect beam alignment is detrimental in OMA-based mmWave massive MIMO, it can be beneficial in sharing a beam with multiple user nodes clustered together and serving those users by virtue of NOMA superposition-coded transmissions. Having been inspired by this observation, in [65], NOMA has been used to circumvent the loss of degrees-of-freedom in finite resolution analog beamforming by serving a set of user nodes via analog beam-sharing.

In [66], the detrimental impact of beam misalignment in mmWave massive MIMO-NOMA systems with hybrid beamforming has been investigated. The optimal analog and digital precoders have been designed based on maximizing the sum rate. To this end, a lower bound of the achievable sum rate has been derived in closed-form by assuming perfectly aligned LoS channels. The impact of misaligned LoS or NLoS channels has been captured by invoking a carefully designed beam misalignment factor. Then, a lower bound of the achievable user rates under beam misalignment has been computed. Finally, an upper bound of the rate gap between the perfectly aligned and misaligned beams has been derived. Thereby, it has been concluded in [66] that the achievable rates can be severely affected when imperfect designs of analog/digital precoders yield beam misalignments in mmWave massive MIMO-NOMA systems.

NOMA has been integrated into mmWave MIMO with lens antenna arrays in [61] and [67]. By adopting the proposed methods, the number of users that can be served simultaneously can exceed the number of RF chains. By invoking a lens antenna array, the conventional spatial MIMO channel can be transformed into beamspace domain via a discrete Fourier transform [70]. Then, the achievable rates have been derived, and the corresponding analysis has been used to design precoders to reduce inter-beam interference and to formulate transmit power control algorithms. In order to maximize the achievable sum rate, a dynamic power allocation scheme has been formulated to minimize intra/inter-beam interference. This dynamic power allocation problem has been solved via a low-complexity iterative optimization algorithm. By exploiting efficient beam selection algorithms for beamspace-domain, it has been revealed in [61] that the achievable spectral and energy efficiency gains can be considerably boosted by integrating NOMA into the beamspace mmWave MIMO.

In all aforementioned related literature on mmWave mas-

sive MIMO NOMA [61], [63]–[66], each clusters of user nodes having similar spatial signatures have been served by a superposition-coded signal through a single beam. However, reference [68] reveals that only a few user nodes can be served via a single beam once mmWave communications is adopted due to extremely narrow beamwidths. To circumvent this issue, the concept of multi-beam mmWave massive MIMO has been proposed in [68]. To this end, multiple beams can be used to serve a single-cluster through efficient antenna partitioning algorithms. Reference [68] concludes that multi-beam NOMA transmissions can significantly boost the achievable rates at the user nodes by mitigating the adverse effects of beam misalignment exhibited in single-beam mmWave massive MIMO NOMA systems. Moreover, in [69], two beamwidth control techniques have been proposed for multi-beam mmWave massive MIMO NOMA via the conventional beamforming and the Dolph-Chebyshev beamforming. By computing the main lobe power losses incurred by the proposed beamwidth control, reference [69] proposes an effective analog beamformer, a novel resource allocation scheme, and a NOMA user grouping algorithm based on the coalition formation game theory to boost the overall system performance.

Conclusions and Future Research Directions In the related prior research on NOMA-enabled massive MIMO [17], [35]–[47], [49]–[52], [61], [63]–[66], [68], [69], the spatial domain has solely been exploited in designing pilot allocations, user groupings/pairings, and related signal processing techniques. Exploitation of the angle domain with array signal processing techniques has recently gained much attention [71]–[73]. To this end, angular models of the massive MIMO NOMA channels can be leveraged to design angle information aided pilot allocation and channel estimation, beamforming and power allocation and interference mitigation techniques by virtue of theory of array signal processing [74].

Deep learning techniques by virtue of artificial neural networks can be a useful tool in enhancing the efficiency of data/model-driven transmitter/receiver designs for NOMA-aided massive MIMO. In particular, the fundamental trade-offs among system parameters involved in channel estimation, transmit power allocation and iterative/SIC decoding can be optimized by virtue of tools in deep learning.

IV. COEXISTENCE OF NOMA AND COOPERATIVE COMMUNICATIONS

Broadly speaking, research contributions on the coexistence of NOMA and cooperative communications can be divided in three categories, namely, cooperative NOMA, relay-aided NOMA communications, and multi-cell NOMA cooperative transmission, as detailed in the following.

A. Cooperative NOMA

The basic principle of cooperative NOMA is to invoke one NOMA user as a relay, as proposed in [75]. More specifically, the transmission process of cooperative NOMA consists of two time-slots. The first time-slot, the BS broadcasts the superposed messages to two NOMA users. At the second time-slot, the user with good channel condition acts as a decode-and-forward (DF) user relay to forward the decoded messages

to the user with poor channel conditions. As a consequence, the reliability of weak user can be improved. Compared to conventional NOMA, the key advantages of cooperative NOMA are that this scheme is capable of achieving low system redundancy, better fairness, and higher diversity gain, which has been summarized in [33]. To elaborate further, an energy efficient energy harvesting cooperative NOMA protocol was proposed in [76], with invoking a stochastic geometry model. Three user selection schemes are proposed based on the user distances from the base station. Although cooperative NOMA is capable of enhancing the performance of poor user's, it costs one extra slot to transmit information. Full duplex relay technique is a possible technique for solving this issue. The applications of full-duplex relay on cooperative NOMA have been considered in [77]–[80]. To further enhance the performance of cooperative NOMA, a two-stage relay selection scheme was proposed in [81] to minimize the outage probability among possible relay selection policies. Considering the spatial effects, the relay selection was investigated in [79], where the spatial random distributed relays are capable of switching between half-duplex mode and full-duplex mode.

B. Relay-aided NOMA

In this context, several relay-aided NOMA communications schemes are proposed for single-cell NOMA networks [82]–[85]. Notably, an amplify-and-forward (AF) multi-antenna relay-aided NOMA downlink network was investigated with obtaining the outage performance in [82]. Regarding the uplink case, a novel relay-aided NOMA scheme was proposed in [83] for multi-cell scenarios, where an Alamouti structure was applied. In [84], a novel coordinated direct and relay-aided transmission scheme was proposed, where the BS communicates with the near user directly while communicates with the far user with the aid of a relay. As a further advance, in [85], the authors proposed a novel two-way relay NOMA scheme, where a pair of NOMA users can exchange their information with the aid of decode-and-forward relay. Relay-aided physical layer security, which is of significant importance in NOMA, will be discussed in Section VI.

C. Multi-cell NOMA Cooperative Transmission

As research contributions in the context of single cell-NOMA have been well researched, researchers recently focus their attention on multi-cell NOMA, such as network NOMA [94], coordinated multi-point cooperative (CoMP) transmission [9], NOMA in heterogeneous networks (HetNets) [87], NOMA in cloud radio access networks (C-RAN) [88], etc. For multi-cell NOMA scenarios, one major concern is how to enhance the performance of cell-edge NOMA users, especially for the downlink case. This is because, typically, the far users (cell-edge user) is not well-served. Another key issue of multi-cell NOMA is to handle the complicated intra/inter cell interference. CoMP is a promising technique to solve the aforementioned issue, by enabling multiple BSs to carry out coordinated beamforming for enhancing the performance of cell-edge user [89]. As multiple antenna techniques are significant for NOMA by bringing additional gain in spatial

domain [90], two novel coordinated beamforming approaches were proposed in multi-cell MIMO-NOMA systems for decreasing the inter-cell interference in [86]. A majorization-minimization-based beamforming is shown to outperform ZF-based beamforming in secure rate optimization of a two-user MIMO-NOMA network in [95]. Moreover, in [92], the outage performance was investigated in downlink C-RAN NOMA networks, where stochastic geometry was used for modeling the locations of BSs and NOMA users. It is worth to point out that there are still several open issues for multi-cell NOMA cooperative transmission [9]. For example, compared to single-cell cooperative NOMA, the SIC decoding order is required to be reconsidered in multi-cell cooperate NOMA as the near user is not necessary to be the user with good channel quality [93]. Moreover, the power control/allocation among users also play a pivotal role for multi-cell NOMA cooperate transmission (especially for HetNets NOMA scenarios [87]) as inappropriate power allocation will result in increased energy consumption hence degrade the system performance. Other issues such as error propagation, hardware complexity for decoding also hinder the implementation of SIC in multi-cell NOMA and need further investigation. A high-level summary of existing works on NOMA with cooperative communication is listed in Table. IV.

D. Discussions and Outlook

There are still several open issues for multi-cell NOMA cooperate transmission [9]. For example, SIC decoding order is required to be reconsidered in multi-cell cooperate NOMA as the near user is not necessary to be the user with good channel quality [93]. Moreover, the power control/allocation among users also plays a pivotal role for multi-cell NOMA cooperate transmission (especially for HetNets NOMA scenarios [87]) as inappropriate power allocation can increase energy consumption and hence degrade the system performance. Other issues such as error propagation, hardware complexity for decoding also hinder the implementation of SIC in multi-cell NOMA [9], [10]. More research contributions are required to make multi-cell NOMA practical.

V. INTERPLAY BETWEEN NOMA AND COGNITIVE RADIO NETWORKS

Proposed by Mitola in 2000 [96], the concept of cognitive radio (CR), which allows the unlicensed secondary users to opportunistically access the licensed primary users' spectrum, has received significant attention both in industry and academia. CR can be broadly categorized as three paradigms, overlay [97], [98], underlay [99] and interweave [100], [101] (see Table 8 of [33] for the detailed comparison of the three schemes). Given the fact that both NOMA and CR techniques are capable of enhancing the spectral efficiency, a natural question arises: Can NOMA and CR coexist to achieve an improved spectral efficiency? The investigation of co-existence of NOMA and CR can be summarized from two aspects: 1) The application of NOMA in CR networks; 2) The cognitive radio inspire NOMA, which will be detailed in the following.

TABLE IV
SUMMARY OF EXISTING WORKS ON NOMA AND COOPERATIVE COMMUNICATIONS

Category	Transmission	Advantages/Contributions	References
Cooperative NOMA	Downlink	Lower system redundancy, enhanced fairness and diversity gain	[75]–[81]
Relay-aided NOMA	Downlink/Uplink	Extend the network coverage	[82]–[85]
Multi-cell cooperate NOMA	Downlink/Uplink	Enhance the performance of cell-edge users and increase spectral efficiency	[9], [86]–[93]

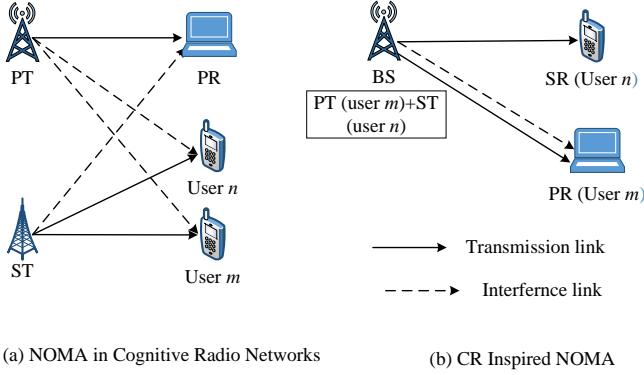

Fig. 2. Interplay between NOMA and cognitive radio networks.

A. NOMA in Cognitive Radio Networks

The key idea of applying NOMA in CR networks is to allow the secondary transmitter (ST) to communicate with multiple secondary NOMA users as long as the interference power constraint at the primary user (PUs) is satisfied. Fig. 2 (a) illustrates a two-user case NOMA in CR networks, where ST is capable of communicating with User n and User m simultaneously. In [102], the authors first proposed to apply NOMA in large-scale CR networks with the aid of invoking stochastic geometry model. A general NOMA-CR scenario is considered, where one ST is capable of communicating with multiple NOMA SUs. As a further advance for the application of NOMA in CR networks, in [103], the authors proposed a cooperative NOMA-CR scheme for enabling multiple SUs to serve as relays to aid transmission. Moreover, for further enhancing the spectral efficiency, two novel NOMA-CR user scheduling schemes were considered in [104] to ensure NOMA users to be scheduled either efficiently or fairly.

B. Cognitive Radio-inspired NOMA

In this subsection, the CR inspired NOMA is introduced. As proposed in [105], the key concept of CR inspired NOMA is essentially a novel power allocation scheme. As shown in Fig. 2 (b), we can consider the BS as a combination of the primary transmitter (PT) and ST, which transmits the superposition-coded signals. The rationale behind CR inspired NOMA is to ensure the quality-of-service (QoS) of the weak user (User m) by limiting the power allocated to the strong user (User n). In this case, we can still investigate this scheme with the aid of the key feature of classic underlay CR. In [105], the impact of user pairing on the performance of both fixed power allocation and CR inspired NOMA has been investigated. A more general power allocation scheme for guaranteeing the QoS in both downlink and uplink NOMA

systems has been considered in [106]. By applying such a scheme, it is more flexible to achieve the throughput/fairness tradeoff. Regarding the extension to MIMO scenarios, the authors in [107] apply the CR inspired NOMA for solving the power allocation issue in MIMO-NOMA networks with the aid of signal alignment.

The aforementioned existing research contributions in the context of the interplay between CR and NOMA networks mainly focus on underlay CR. The research on interweave NOMA-CR and overlay NOMA-CR is still in its infancy, and thus, research advancements on the corresponding open problems are expected in the future. It is also worth pointing out that proper resource management, such as power allocation, user clustering, and user pairing can be considered to further enhance the system performance of NOMA-CR networks.

C. Discussions and Outlook

Existing research on NOMA-CR networks mainly focus on underlay CR. The works on interweave overlay NOMA-CR are still in their infancy. Better resource management, such as power allocation and user clustering, can be considered to further enhance the system performance of NOMA-CR networks. The use of machine learning, and deep learning, has attracted extensive research interest to enable intelligent CR from both physical layer and resource allocation [108], [109]. There is still a long way to realize intelligent NOMA-CR before we solve the following challenges:

- **NOMA-CR-enabled massive connectivity:** To support massive connectivity with low power consumption, low-power wide-area techniques, such as narrow-band IoT and LoRa, have been proposed to support short packet transmission [110]. Since many IoT devices are power constrained, it is worth investigating NOMA-CR techniques with low power consumption to make them applicable to massive connectivity of IoT devices.
- **Intelligent/distributed resource management:** Resource allocation in NOMA-CR has been investigated extensively. important emerging applications such as unmanned aerial vehicles (UAVs) and vehicle-to-everything (V2X) pose stringent challenges on intelligent resource management. Existing resource allocation schemes are implemented in a centralized approach [111] which may not be suitable for dynamic UAV deployment as UAVs are expected to make a decision locally [112]. A distributed spectrum sharing scheme has been proposed in [113] for the V2X links. More efficient spectrum sharing schemes are expected for the NOMA-CR systems.

VI. NOMA AND PHYSICAL LAYER SECURITY

Due to the broadcast nature of wireless transmissions, securing transmitted data from potential external eavesdroppers and internal eavesdroppers (untrusted nodes in the network) is a critical system design aspect that needs careful consideration. PHY security is a powerful tool to achieve the goal of a provably unbreakable, secure communications. PHY security techniques exploit the physical aspects of communication channels between the nodes to introduce security in wireless communication systems. Today, several PHY security techniques are known to guarantee secure communication in the context of wiretap channel. Some can guarantee security even if the legitimate user's channel is worse than the eavesdropper's channel. Most notably among them are *artificial noise* (AN) transmission to confuse the eavesdropper [114], various beamforming approaches [115]–[118], transmit antenna selection [119]–[121], cooperative jamming and relay-based PHY security systems [122]–[124]. The above approaches are, in general, applicable to NOMA-based networks [125], and many of them have already been investigated in this context, as described below. A two-user MIMO-NOMA with an external eavesdropper is shown in Fig. 3.

A. AN-aided Secure NOMA

AN-aided approaches inject an artificial noise into directions orthogonal to those of the main channel and are of great importance when the eavesdropper's CSI is not available at the transmitter. Different AN-aided secure NOMA systems are studied in [126]–[130]. Specifically, the secrecy outage performance of a multiple-input single-output (MISO) NOMA system is derived in [126]. A MISO-NOMA-CR network using SWIPT is studied in [127], in which AN-aided cooperative jamming is used to improve the security of the primary network. Jamming signal is transmitted by the cognitive BS to cooperate with the primary BS to improve the security of the primary user. Ergodic secrecy rates of the users of an AN-aided massive MIMO-NOMA network is derived in [128]. Asymptotic expressions reveal that the AN only affects the eavesdropper when the number of antennas is sufficiently large.

Using tools from stochastic geometry, a large-scale NOMA system is studied in [129] in which the BS can have single or multiple antennas while the users are assumed to have a single antenna. For the multi-antenna BS, AN is generated at the BS. In both cases, analytical expressions for the secrecy outage probability are derived. Stochastic geometry based techniques are used to model the locations of the legitimate users and eavesdropper, i.e., to deploy them at spatially random locations.

B. Cooperative Transmission-based Secure NOMA

Several independent works [130]–[133], [137] have considered improving the security of NOMA-based systems using cooperative transmission. Analytical expressions for the secrecy outage probability of a cooperative SISO-NOMA with an eavesdropper and a single relay with both AF and DF

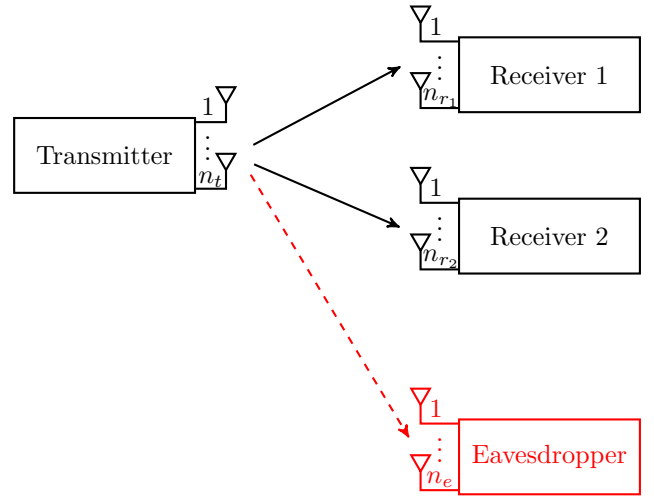

Fig. 3. A two-user MIMO-NOMA with one external eavesdropper [125]. All nodes are equipped with multiple antennas. This basic model can be extended in several ways, see [125] for more details. Each NOMA user may also be seen as an (internal) eavesdropper to the other NOMA user.

protocols are derived in [137]. In [131], [138], [139], SISO-NOMA-based transmission models with *trusted* and *untrusted* cooperative relays are studied under cooperative jamming, AF, and DF protocols. In the case of trusted relays [138], there are multiple cooperative relays, two legitimate users, and an external eavesdropper whereas the number of relays in the untrusted case [139] is just one. Achievable secrecy rate regions are derived in the above settings show that the best relaying scheme depends on different parameters, such as the distances between the nodes and also on which part of the secrecy rate region the system is to operate at. In particular, cooperative jamming is shown to outperform AF and DF when the relays get closer to the eavesdropper since the jamming effect is more powerful in such a case. Remarkably, in all the relaying schemes, strictly positive secrecy rates are achievable while secrecy rates can be zero without relays. Secrecy in the context of NOMA VLC has been investigated in [140], in which a two-user downlink is considered with an external eavesdropper. Under amplitude (peak power) constraints in the transmitted signals, imposed by the LEDs, achievable secrecy rate regions are derived with uniform signaling. Various relaying schemes are then shown to enhance the rate regions, also under peak power constraints at the relay luminaries.

Cooperative jamming is a popular and effective method in improving the security in the PHY layer. In [130], a NOMA-based two-way relay network in the presence of single and multiple eavesdroppers is studied. To ensure secure communications, the relay both forwards confidential information to the legitimate users and emits jamming signals. An overlay NOMA-CR network with multiple primary and secondary users under the secrecy constraint on primary users is proposed in [132] to improve the secrecy outage performance. Similar to [130], the motivation is to give the secondary transmitter the opportunity to access the spectrum of primary users in exchange of relaying the message of them. A cooperative

TABLE V
SUMMARY OF TECHNICAL CONTRIBUTIONS ON NOMA-RELATED PHYSICAL LAYER SECURITY

References	System model	Technical contribution
[126]	Two-user MISO-NOMA	Secrecy outage probability is evaluated
[127]	K -user MISO-NOMA cognitive radio network	AN-aided cooperative jamming is used to improve the security of the primary user
[128]	Massive MIMO-NOMA	Ergodic secrecy rate is evaluated
[129]	Large scale SISO/MISO-NOMA	Secrecy outage probability is derived
[130]	Two users, one trusted relay, and multiple eavesdroppers	Jamming is transmitted to increase security and achievable ergodic secrecy rates are derived
[131]	Two-user SISO-NOMA with external eavesdroppers	Secrecy rates are derived with different trusted/untrusted relaying including cooperative jamming
[132]	SISO NOMA-CR where secondary users are eavesdroppers	Connection outage probability, secrecy outage probability, and effective secrecy throughput are derived for the primary users
[133]	Cooperative SISO-NOMA with an external eavesdropper	Expressions for the ergodic secrecy rates are derived in the presence of an eavesdropper where he source transmits jamming signals
[134]	Two-user SISO-NOMA with an untrusted relay	Effective secrecy throughput is derived where cooperative jamming is designed to confuse the relay
[135], [136]	MIMO-NOMA	TAS-based security; secrecy outage probability/secrecy diversity order over Nakagami- m fading channels are derived

relaying scheme to enhancing the security of a SISO-NOMA system is considered in [133]. The source sends jamming signals while the relay is forwarding the message. In this model, there is no external eavesdropper, but one of the NOMA users is seen as an eavesdropper. Cooperative jamming is also applied in [131], as explained previously.

C. Transmit Antenna Selection (TAS)-based Strategies

MIMO systems are conceived to increase reliability (on account of diversity) or to achieve high data rates (due to the multiplexing gain). This performance improvement of MIMO systems can potentially scale up with the number of antennas [91]. However, the improvements obtained through MIMO come at the price of a complex front-end architecture and expensive RF chains. Transmit antenna selection (TAS) is an effective technique that uses a single RF chain (rather than multiple parallel RF chains) to reduce cost, complexity, size, and power consumption while keeping the diversity and throughput benefits acceptably high. This technique can also improve security in the presence of eavesdroppers [119]–[121]. TAS has recently been applied to improve the security of MIMO-NOMA systems in [135], [136]. Various TAS strategies are studied in [135] and closed-form expressions for the secrecy outage probability are obtained. In [136], a max-min TAS strategy is utilized at the BS to improve the secure performance, and to obtain the secrecy outage probability and to derive the available secrecy diversity order over Nakagami- m fading channels. The literature of NOMA with PHY security is summarized in Table. V.

D. Beamforming-based Strategies

Beamforming is one of the most popular approaches in PHY security for multi-antenna systems. ZF beamforming, which is popular for the multi-user MIMO systems [141], tries to send the signal as orthogonal to the eavesdropper's

channel as possible. When the transmitter has a larger number of antennas than the eavesdropper, it is possible to transmit the information in the *null space* of the eavesdropper's channel. This simple suboptimal approach tends to be asymptotically optimal in the massive MIMO case [16] and eliminates all the inter-user interference under perfect CSI. Linear beamforming based on the *generalized singular value decomposition* and *generalized eigenvalue decomposition* [115], [142], rotation-based beamforming [118], [143], and numerical solutions are used to form the transmit covariance matrix for the secrecy rate maximization in the MISO and MIMO wiretap channels.

E. Future Research Directions

Most of the above PHY security solutions are limited to the study of two-user NOMA systems with limited nodes. Extending those solutions to large-scale networks with multiple users in each cluster is of a great importance. Moreover, the extension of beamforming-based approaches to NOMA-based systems is not trivial and can be seen as a good avenue for future research. In the case of beamforming and artificial noise based secrecy a few solutions with imperfect CSI exist. Further, perfect SIC is assumed in the majority of NOMA PHY security papers, which may lead to overestimating the performance of the networks considered. Future research may address the above issues.

VII. NOMA WITH ENERGY HARVESTING

In this section, we discuss how energy harvesting technologies, mainly through SWIPT and WPCN, affect different performance metrics of NOMA, such as energy efficiency, achievable rates and outage probabilities, as reported in [144]–[168].

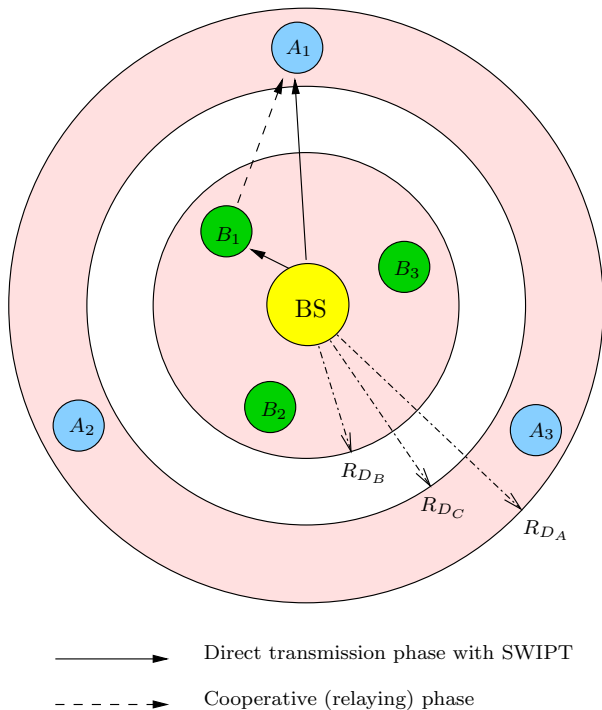

Fig. 4. A NOMA SWIPT system in which users close to the BS, labeled $\{B_i\}$, cooperatively assist the BS with transmitting data to further users, labeled $\{A_i\}$ [144].

A. NOMA with SWIPT

In [144]–[151], SWIPT is used to incentivize stronger downlink NOMA users, i.e., users that are relatively closer to the BS and have better channel conditions, to forward data to weaker users, using energy harvested from the transmitted signals from the BS. Other works [152]–[155] focus on WPCN for NOMA uplink communications, in which the BS first transfers an amount of energy wirelessly to a number of users that is then used to let them communicate back to the BS in the uplink using NOMA. Similar ideas are investigated in [156], [157], yet with the additional consideration of energy used in circuitry and hardware operations. Different from [144]–[151], references [158]–[164] consider dedicated relaying nodes that rely on SWIPT to forward data to multiple users using NOMA. The works in [165], [166] use SWIPT within a cognitive radio NOMA framework. Designing modulation schemes for a two-user NOMA downlink, with an additional energy harvesting user, is considered in [167]. The concept of energy cooperation among NOMA BSs is discussed in [168]. In what follows, we discuss some of the above-mentioned works in more detail.

Reference [144] considers the model in Fig. 4, in which users are categorized into near users, deployed within a disc of radius R_{DB} around the BS according to a homogeneous Poisson point process (PPP), and far users, deployed within a ring of inner and outer radii R_{DC} and R_{DA} , respectively, according to another homogeneous PPP. It is assumed that $R_{DC} \gg R_{DB}$, and therefore near users assist the BS with relaying the far users' messages. Using SWIPT with power splitting, the near users harvest energy from the BS's signals in order to use it during the relaying phase. The far users then

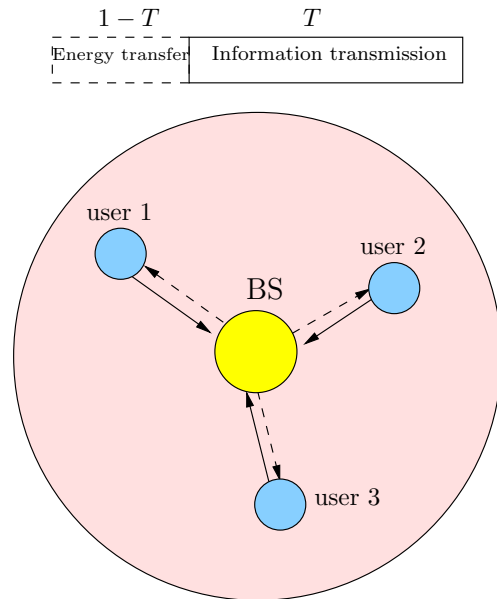

Fig. 5. Wireless energy transfer from the BS to the users to power the uplink transmission from the users to the BS via NOMA [152].

employ maximum ratio combining to optimally combine the signals received from the BS and the near users.

Using this idea, reference [144] presents some answers regarding how to pair near and far users together for such operation. Specifically, three user pairing strategies are investigated: 1) random near user and random far user (RNRF), in which pairing is assigned randomly; 2) nearest near user and nearest far user (NNNF), in which the nearest near and far users to the BS are paired; and 3) nearest near user and farthest far user (NNFF), in which a near user that is closest to the BS is paired with a far user that is farthest from the BS. It is shown that the best pairing strategy is NNNF, in the sense that it minimizes the outage probability and maximizes the achievable rates for both near and far users, which are derived in closed-form. This work concludes that by carefully choosing transmission rates and power splitting coefficients, one can achieve guaranteed performance results without the need to use the near users' own energy to power the relay phase transmission.

B. NOMA with WPCN

The model depicted in Fig. 5 is considered in [152], in which a sequential energy transfer and information transmission is undertaken. The authors formulate different optimization problems to choose the best time duration T that either maximizes the total achievable sum rate or maximizes the minimum achievable rate among the users so as to promote fairness. In addition, varying decoding orders are considered at the BS, where for a fraction τ_m , $m = 1, \dots, M$, of the time duration T a specific decoding order is employed, with M denoting the total number of possible decoding orders considered. This latter method is denoted by *time sharing*. The best time sharing vector $\tau \triangleq [\tau_1, \dots, \tau_M]$ is then chosen to maximize either the sum or the minimum achievable rate,

TABLE VI
SUMMARY OF TECHNICAL CONTRIBUTIONS ON NOMA WITH ENERGY HARVESTING

References	Technical contribution
[144]–[151]	SWIPT to stronger NOMA users for relaying purposes to weaker users
[152]–[155]	WPCN to power NOMA users for uplink transmission
[156], [157]	Consideration of circuitry power consumptions
[158]–[161], [163], [164]	SWIPT to dedicated relaying nodes that forward data to NOMA users
[165], [166]	SWIPT in cognitive radio NOMA settings
[167]	Modulation schemes design for additional energy harvesting users
[168]	Energy cooperation among NOMA BSs

subject to $\sum_{m=1}^M \tau_m \leq 1$. All considered problems are shown to be either linear or convex, which facilitates reaching an optimal solution in practice. One conclusion of this work is that implementing NOMA with WPCN offers an increase in user fairness, when compared to conventional OMA techniques, when the users' transmissions are constrained by the harvested energy.

Reference [157] considers WPCN for uplink transmission, as in [152], yet with considering the energy consumed in circuitry operations. That is, it is assumed that each device consumes a constant amount of (passive) power, p_c , accounting for its transmit filter, mixer, synthesizer, etc. The authors compare two uplink transmission schemes following the wireless power transfer: TDMA (or OMA) and NOMA, in terms of energy and spectral efficiencies. It is shown that when $p_c > 0$, TDMA is better in terms of both energy and spectral efficiency. It is therefore crucial to have an accurate power consumption model, especially for energy-constrained devices, before deciding on transmission schemes in general. In Table VI, we briefly mention the main technical contributions of the works that considered NOMA with energy harvesting in the recent literature.

C. Future Research Directions

One interesting future direction in this line of research is to extend the concepts above to MIMO settings while considering the energy used in circuitry operations. While, in general, having multiple antennas delivers higher performance guarantees, it also consumes more circuitry power. Therefore, a tradeoff may exist in this situation between the number of antennas and the (passive) circuitry costs that needs to be optimally characterized. Another direction is to consider a combined SWIPT-WPCN settings, in which users divide their received energy from the BS into two main portions: one with which they relay data to other users in the network, and the other with which they communicate back to the BS in the uplink. Choosing the optimal portions in this situation would depend on the overall objective of the network. Finally, more practical signal design aspects for SWIPT should be taken into consideration as well. For instance, it is discussed in [169] that there can exist some dominant non-linear terms, in the

transmitted signal power, that govern the amounts of received energy. This completely changes the transmitted signal design, and hence the communication rates as well. It would therefore be of interest to apply the ideas of [169] in the context of NOMA. Interference harvesting [170] is another appealing idea that can be applied in this context.

VIII. NOMA WITH VISIBLE LIGHT COMMUNICATIONS

In this section, we discuss how NOMA techniques can be applied in the context of VLC, as reported in [171]–[182]. A typical two-user VLC NOMA downlink is shown in Fig. 6.

A. Existing Literature of NOMA-VLC

The setting in which some ϵ fraction of the interference is not canceled at the strong user after employing SIC is considered in [171], [172]. Reference [171] considers a two-user downlink and compares NOMA-based VLC transmission with conventional OFDMA. Superiority of the achievable rate region using NOMA is shown. In [172], the authors make use of the relatively high precise positioning in VLC to group NOMA users based on their locations. Within the group, SIC is employed for users with relatively better channel conditions. Two problems are formulated to decide on the power allocations among the users: one for maximizing the sum rate, and another for maximizing the minimum rate, subject to minimum QoS requirements for the users. The problems are solved iteratively after casting the problems into convex forms.

The work in [173] proposes a gain ratio power allocation (GPRA) technique to set the power allocated to each NOMA user based on its channel quality. The motivation is to ensure fairness among the users with low decoding order that suffer large interference. The effect of tuning the transmission angles of the LEDs is also studied.

Comparing NOMA to OFDMA is also undertaken in [174], in which outage probability expressions are derived for guaranteed QoS provisioning for a NOMA downlink, as well as ergodic sum rate expressions for opportunistic best effort service provisioning. The impact of LED lighting characteristics is also shown in this work.

MIMO-NOMA for VLC is considered in [175], [176]. In [175], normalized gain difference power allocation (NGDPA) strategies are employed, and detection is carried on via zero forcing followed by SIC. Improvements in achievable sum rates under the NGDPA strategy with respect to a generalization of the GPRA strategy of [173] to the MIMO case, is shown via simulations. As the name suggests, in NGDPA, the power allocated is proportional to the normalized difference of channel gains between users, as opposed to the ratio of channel gains in GPRA. In [176], a Chebyshev precoder is proposed based on singular value decomposition of the MIMO channel gain matrix for each NOMA user, in order to improve the performance of nonlinear LED compensation.

Peak power constraints, imposed by the LEDs to avoid clipping distortion, are considered in [177], [178]. Reference [177] studies sum rate maximization problems, subject to user fairness and peak power constraints. Under logarithmic

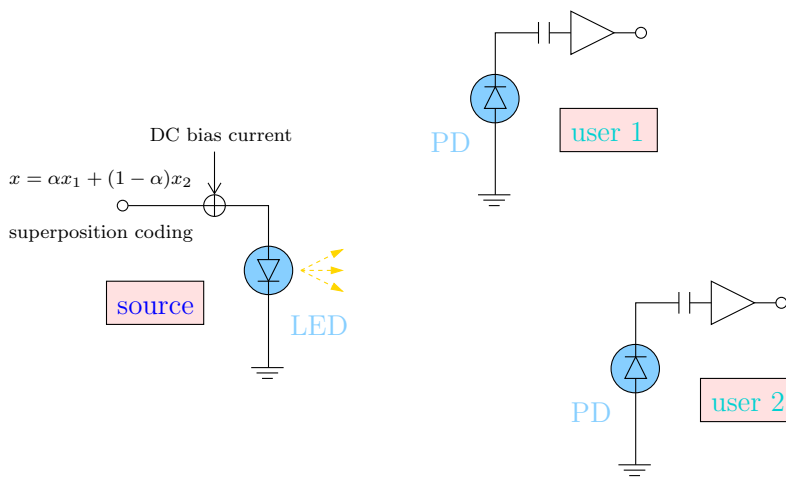

Fig. 6. A two-user VLC NOMA downlink, in which superposition coding is used to drive the LED's DC bias current in order to send two messages to two users.

TABLE VII
SUMMARY OF TECHNICAL CONTRIBUTIONS ON NOMA WITH VISIBLE
LIGHT COMMUNICATIONS

References	Technical contribution
[171], [174]	Superiority of VLC NOMA to OFDMA
[172]	Grouping of NOMA users based on VLC positioning
[173]	Power allocation for fairness considerations
[175], [176]	MIMO VLC NOMA settings
[177], [178]	Amplitude (peak power) constraints for VLC NOMA systems
[179], [180]	User mobility aspects and effects on VLC NOMA systems
[181], [182]	Experimental demonstrations and practical modulation schemes

fairness, the proposed non-convex problems are efficiently converted to convex ones. Optimal power control algorithms are then derived using a Lagrangian framework and is shown to outperform other power allocation strategies, such as GPRA of [173]. In [178], closed-form expressions for the bit error rate under perfect CSI are derived. The effect of delayed and noisy (imperfect) CSI is also studied.

User mobility is considered in [179], [180]. Reference [179] considers the setting in which users randomly change their locations according to some distribution, and derives outage probability and sum rate expressions based on various NOMA users scheduling criteria. Both static and mobile users are considered in [180], for which upper and lower bounds on achievable rates are derived. Transmit power minimization problems are then formulated and solved by semi-definite relaxation techniques.

On a more practical aspect, an experimental demonstration is presented in [181] for a bidirectional NOMA-OFDMA VLC network, and symmetric modulation techniques are proposed [182] to mitigate SIC error propagation in a downlink VLC-NOMA system.

In Table VII, we briefly mention the main technical contributions of the works that considered NOMA with VLC in the

recent literature.

B. Future Research Directions

Future directions for this line of research include a thorough investigation of optimal signaling schemes for VLC in the context of NOMA. Specifically, one differentiating aspect between VLC and other means of communications is the extra amplitude (peak power) set of constraints on the transmitted signals, which are imposed to maintain operation within the LEDs' dynamic range and to avoid clipping distortion. In these scenarios, Gaussian signaling is not even feasible, let alone optimal. Some candidate signaling schemes include: uniform, truncated Gaussian, and discrete signalings. A careful comparison between the rates achieved by these various signaling schemes is hence important, especially in MIMO settings, to realize NOMA VLC in practical scenarios.

IX. NOMA WITH MOBILE EDGE COMPUTING

Mobile edge computing (MEC) brings computation/storage resources to the mobile users at the edge of network. As shown in Fig.7, NOMA can be combined with MEC both in the uplink and downlink. By applying NOMA into MEC, multiple users can offload their task simultaneously in the same frequency band. Therefore, the combination of NOMA and MEC can provide massive connectivity, low latency and high spectral efficiency.

A. Combination of NOMA with MEC

Applying uplink and downlink NOMA transmission into MEC offloading reveals that NOMA-MEC can provide lower latency and lower energy consumption than the traditional OMA scheme [183]. Resource optimization, however, plays an important role in NOMA-MEC, and as such, optimization of communication resource (e.g., offloading power, occupied frequency bandwidths, offloading time) and computing resource (e.g., task assignment and computing resource blocks) has recently attracted lots of attention. Typical objectives of the resource optimization are energy consumption minimization

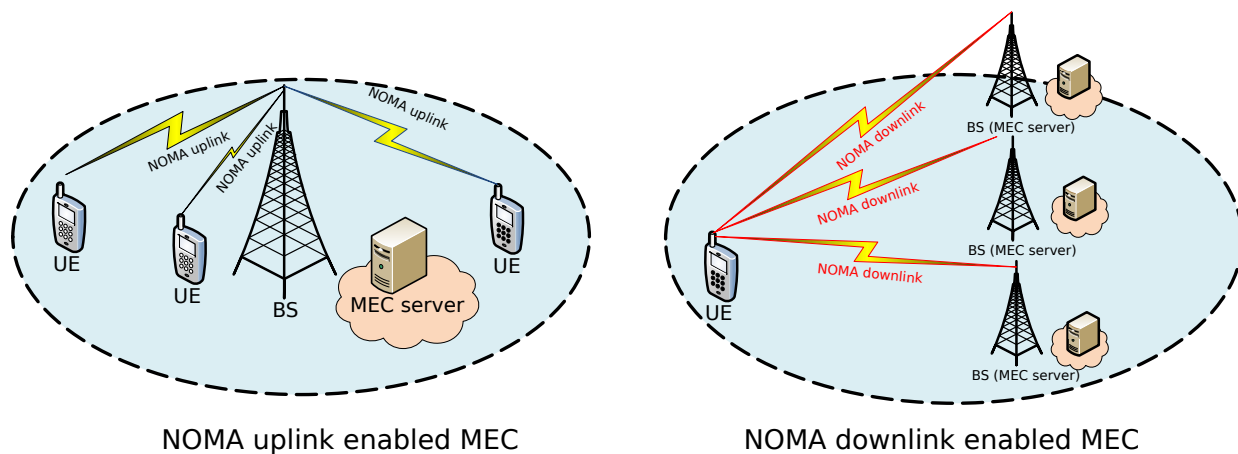

Fig. 7. NOMA-MEC scenarios in the uplink and downlink.

[184]–[186] and task delay minimization [187]. Among these works, *partial* offloading and binary offloading are two main offloading schemes for NOMA-MEC. An energy efficient NOMA-MEC design is investigated in [184], in which both partial offloading and binary offloading are considered to minimize the weighted sum-energy consumption. Considering fully offloading scheme, where the task needs to be offloaded to the MEC server for remote computation, a hybrid NOMA-MEC system is proposed in [185]. In this hybrid NOMA-MEC system, the user can offload parts of its task in the time-slot allocated to another user, and then offload the remaining task by its own allocated time-slot. The power allocation and offloading time are optimized to minimize the energy consumption [185]. Subsequently, the delay minimization is investigated on this hybrid NOMA-MEC system by using Dinkelbach method and Newton’s method in [187], which reveals that these two methods converge to the same point, and Newton method converges faster than Dinkelbach method. Further, closed-form expressions of optimal task assignment and transmit power were presented in [188] to minimize the task delay in NOMA-MEC. In the binary offloading NOMA-MEC, communication and computing resource are jointly optimized to minimize the energy consumption for NOMA-MEC system [186]. When downlink NOMA transmission is applied into MEC systems, the mobile device can offload its tasks to several BSs equipped with MEC servers. By applying superposition coding at the mobile devices and SIC at BSs, the signals received at BSs has low interference. In this scenario, the transmit power and offloading task can be optimized to minimize the energy consumption of the NOMA enabled MEC system [189].

B. Future Research Directions

The following provides some potential research directions for NOMA-MEC.

1) *Joint computation and communication resource optimization*: In the uplink transmission of NOMA-MEC, the BS equipped with MEC server has considerable computation resource to provide the mobile devices remote computation. Mobile devices can optimize the communication resource,

i.e., transmit power and subcarrier allocation, to improve the performance of the system. Joint resource allocation is an inevitable trend to reduce the task delay and energy consumption of NOMA-MEC. In the downlink transmission of NOMA-MEC, computation capacity (i.e. central processing unit (CPU) frequency of MEC server or mobile device) and transmit power are also important factors to reduce the computation latency and energy consumption reduction.

2) *NOMA-MEC with imperfect CSI*: Existing research in NOMA-MEC mainly focus on perfect CSI. Imperfect CSI is one of the key obstacles in realizing the performance gain of NOMA in practice and may results in ambiguous decoding order of SIC. Improving the performance of NOMA-MEC with imperfect CSI including channel estimation errors, partial CSI, and limited channel feedback is an important research direction.

3) *Security in NOMA-MEC*: When NOMA is applied into MEC offloading, secrecy and privacy must be a concern since a passive or active eavesdropper may attempt to decode the mobile users’ message. To address the scenario with external eavesdropper, PHY security can be utilized in NOMA-MEC system.

4) *Cooperative NOMA-MEC*: When the mobile device is too far away from the main MEC server, the cooperative NOMA-MEC can be adapted to improve the connectivity of the network. In this scenario, one mobile device can help the far mobile device offload their tasks to the main MEC server. The mobile device transmits the superimposed signals to the primary MEC server and the helper, which acts as a relay helping MEC server. In this scenario, the performance analysis and resource allocation can be carried out for cooperative NOMA-MEC systems.

X. NOMA WITH OTHER TECHNOLOGIES AND TOOLS

Apart from the previously mentioned technologies, NOMA is also being combined with many other technologies. Particularly, NOMA has been integrated to vehicular communications [190], terrestrial-satellite communications [1], UAVs [112], ambient backscatter communication [191], wireless caching

TABLE VIII
SUMMARY OF EXISTING WORKS ON NOMA-MEC

Topic	Frameworks	References	Contributions
Architecture of NOMA-MEC	Uplink/downlink NOMA MEC	[183]	NOMA-MEC outperforms OMA MEC on lower latency and lower energy consumption than the traditional OMA scheme
Energy consumption minimization	Partial offloading	[184], [189]	Resource allocation schemes are proposed to minimize the energy consumption for a uplink and downlink NOMA enabled MEC system
	Binary offloading	[185], [186]	A hybrid NOMA-MEC system is proposed to minimize energy consumption
Task delay minimization	Partial offloading	[188]	Optimal task and power allocation is proposed to minimize the task delay in NOMA-MEC system
	Binary offloading	[187]	Dinkelbach and Newtons methods are compared to minimize task delay for the hybrid NOMA-MEC system

[192]–[194], Wi-Fi networks [195], and so on. Typical challenges are very similar to the ones discussed earlier, and include clustering, power allocation, SIC performance, etc.

Besides its great flexibility in being combined with other technologies, NOMA has successfully adopted different tools such as stochastic geometry, machine learning, and deep learning (DL) to solve large-scale and NP-hard problems that appear in related optimization problems in the uplink and downlink NOMA [196]–[200]. Particularly, DL has recently been applied to different problems. In [199], DL is used for power allocation a caching based NOMA in three phases: exploration, training, and exploitation. The exploration tries to learn which action returns the best reward for each state, and gives a list of states and the corresponding best actions. Due to its complexity, for the training phase, deep neural networks are built. Finally, the trained model is used to perform the power allocation for every state. In [200], DL is proposed to determine a solution of the joint downlink resource allocation problem for a SWIPT-enabled multi-carrier NOMA system with a time switching-based receivers.

In [199], DL is used for power allocation a caching based NOMA in three phases: exploration, training and exploitation. The exploration tries to learn which action returns the best reward for each state, and gives a list of states and the corresponding best actions. Due to its complexity, for the training phase, deep neural networks are built. Finally, the trained model is used to perform the power allocation for every state. In [200], DL is proposed to determine a solution of the joint downlink resource allocation problem for a SWIPT-enabled multi carrier NOMA system with a time switching-based receivers.

XI. CONCLUSION

In this paper, we have reviewed the research contributions of NOMA combined with several other technologies for 5G wireless networks and beyond, including sub-6 GHz and mmWave massive MIMO, cognitive and cooperative communications, physical layer security, visible light communications, energy harvesting, mobile edge computing, and machine learning and deep learning. It is elaborated how the combination of NOMA with these technologies can overcome certain limits that those technologies are not able to overcome single-handedly. Challenges and future research directions in line with this have also been discussed.

REFERENCES

- [1] M. Vaezi, Z. Ding, and H. V. Poor, *Multiple Access Techniques for 5G Wireless Networks and Beyond*. Springer, 2019.
- [2] Y. Saito, Y. Kishiyama, A. Benjebbour, T. Nakamura, A. Li, and K. Higuchi, “Non-orthogonal multiple access (NOMA) for cellular future radio access,” in *Proc. IEEE VTC Spring*, 2013, pp. 1–5.
- [3] Z. Ding, Y. Liu, J. Choi, Q. Sun, M. Elkashlan, I. Chih-Lin, and H. V. Poor, “Application of non-orthogonal multiple access in LTE and 5G networks,” *IEEE Commun. Mag.*, vol. 55, no. 2, pp. 185–191, 2017.
- [4] T. M. Cover and J. A. Thomas, *Elements of Information Theory*. New York: John Wiley & Sons, 2006.
- [5] A. El Gamal and Y. H. Kim, *Network Information Theory*. Cambridge University Press, 2011.
- [6] D. Tse and P. Viswanath, *Fundamentals of Wireless Communication*. Cambridge university press, 2005.
- [7] T. Han and K. Kobayashi, “A new achievable rate region for the interference channel,” *IEEE Trans. Inf. Theory*, vol. 27, no. 1, pp. 49–60, January 1981.
- [8] M. Vaezi and H. V. Poor, “Simplified Han-Kobayashi region for one-sided and mixed Gaussian interference channels,” in *Proc. IEEE ICC*, 2016, pp. 1–6.
- [9] W. Shin, M. Vaezi, B. Lee, D. J. Love, J. Lee, and H. V. Poor, “Non-orthogonal multiple access in multi-cell networks: Theory, performance, and practical challenges,” *IEEE Commun. Mag.*, vol. 55, no. 10, pp. 176–183, 2017.
- [10] M. Vaezi, R. Schober, Z. Ding, and H. V. Poor, “Non-orthogonal multiple access: Common myths and critical questions,” *IEEE Wireless Commun.*, 2019.
- [11] 3GPP TD RP-150496, “Study on Downlink Multiuser Superposition Transmission,” Mar. 2015.
- [12] T. L. Marzetta, “Noncooperative cellular wireless with unlimited numbers of base station antennas,” *IEEE Trans. Wireless Commun.*, vol. 9, no. 11, pp. 3590–3600, Nov. 2010.
- [13] L. Lu, G. Y. Li, A. L. Swindlehurst, A. Ashikhmin, and R. Zhang, “An overview of massive MIMO: Benefits and challenges,” *IEEE J. Sel. Topic Signal Processing.*, vol. 8, no. 5, pp. 742–758, Oct. 2014.
- [14] F. Rusek, D. Persson, B. K. Lau, E. G. Larsson, T. L. Marzetta, O. Edfors, and F. Tufvesson, “Scaling up MIMO: Opportunities and challenges with very large arrays,” *IEEE Signal Process. Mag.*, vol. 30, no. 1, pp. 40–60, Jan. 2013.
- [15] E. G. Larsson, O. Edfors, F. Tufvesson, and T. L. Marzetta, “Massive MIMO for next generation wireless systems,” *IEEE Commun. Mag.*, vol. 52, no. 2, pp. 186–195, Feb. 2014.
- [16] E. Björnson, E. G. Larsson, and T. L. Marzetta, “Massive MIMO: Ten myths and one critical question,” *IEEE Commun. Mag.*, vol. 54, no. 2, pp. 114–123, 2016.
- [17] K. Senel, H. V. Cheng, E. Björnson, and E. G. Larsson, “What role can NOMA play in massive MIMO?” *IEEE J. Sel. Topic Signal Processing.*, Sep. 2018, IEEE Xplore Early Access.
- [18] T. S. Rappaport, R. W. Heath Jr., R. C. Daniels, and J. Murdock, *Millimeter Wave Wireless Communications*. Prentice-Hall, Englewood Cliffs, NJ, USA, 2014.
- [19] R. W. Heath, N. Gonzalez-Prelcic, S. Rangan, W. Roh, and A. M. Sayeed, “An overview of signal processing techniques for millimeter wave MIMO systems,” *IEEE J. Sel. Areas Commun.*, vol. 10, no. 3, pp. 436–453, Apr. 2016.
- [20] A. Sendonaris, E. Erkip, and B. Aazhang, “User cooperation diversity. part i. system description,” *IEEE Trans. Commun.*, vol. 51, no. 11, pp. 1927–1938, Nov. 2003.

- [21] —, “User cooperation diversity. part II. implementation aspects and performance analysis,” *IEEE Trans. Commun.*, vol. 51, no. 11, pp. 1939–1948, Nov. 2003.
- [22] S. Haykin, “Cognitive radio: Brain-empowered wireless communications,” *IEEE J. Sel. Areas Commun.*, vol. 23, no. 2, pp. 201–220, Feb. 2005.
- [23] A. Mukherjee, S. A. A. Fakoorian, J. Huang, and A. L. Swindlehurst, “Principles of physical layer security in multiuser wireless networks: A survey,” *IEEE Commun. Surv. Tut.*, vol. 16, no. 3, pp. 1550–1573, 2014.
- [24] Y.-S. Shiu, S. Y. Chang, H.-C. Wu, S. C.-H. Huang, and H.-H. Chen, “Physical layer security in wireless networks: A tutorial,” *IEEE Wireless Commun.*, vol. 18, no. 2, 2011.
- [25] X. Chen, D. W. K. Ng, W. Gerstacker, and H.-H. Chen, “A survey on multiple-antenna techniques for physical layer security,” *IEEE Commun. Surv. Tut.*, 2017.
- [26] Y. Liu, H.-H. Chen, and L. Wang, “Physical layer security for next generation wireless networks: Theories, technologies, and challenges,” *IEEE Commun. Surv. Tut.*, vol. 19, no. 1, pp. 347–376, 2017.
- [27] S. Ulukus, A. Yener, E. Erkip, O. Simeone, M. Zorzi, P. Grover, and K. Huang, “Energy harvesting wireless communications: A review of recent advances,” *IEEE J. Sel. Areas Commun.*, vol. 33, no. 3, pp. 360–381, Mar. 2015.
- [28] P. H. Pathak, X. Feng, P. Hu, and P. Mohapatra, “Visible light communication, networking, and sensing: A survey, potential and challenges,” *IEEE Commun. Surveys Tuts.*, vol. 17, no. 4, pp. 2047–2077, Fourth-quarter 2015.
- [29] P. Mach and Z. Becvar, “Mobile edge computing: A survey on architecture and computation offloading,” *IEEE Commun. Surveys Tuts.*, vol. 19, no. 3, pp. 1628–1656, 2017.
- [30] Z. Ewi, J. Yuan, W. K. N. Derrick, E. Maged, and Z. Ding, “A survey of downlink non-orthogonal multiple access for 5G wireless communication networks,” *ZTE Commun.*, vol. 14, pp. 17–25, 2016.
- [31] S. R. Islam, N. Avazov, O. A. Dobre, and K.-S. Kwak, “Power-domain non-orthogonal multiple access (NOMA) in 5G systems: Potentials and challenges,” *IEEE Commun. Surv. Tut.*, vol. 19, no. 2, pp. 721–742, 2016.
- [32] Z. Ding, X. Lei, G. K. Karagiannidis, R. Schober, J. Yuan, and V. K. Bhargava, “A survey on non-orthogonal multiple access for 5G networks: Research challenges and future trends,” *IEEE J. Sel. Areas Commun.*, vol. 35, no. 10, pp. 2181–2195, 2017.
- [33] Y. Liu, Z. Qin, M. Elkashlan, Z. Ding, A. Nallanathan, and L. Hanzo, “Nonorthogonal multiple access for 5G and beyond,” *Proc. IEEE*, vol. 105, no. 12, pp. 2347–2381, Dec. 2017.
- [34] Sprint unveils six 5G-ready cities; significant milestone toward launching first 5G mobile network in the U.S. [Online]. Available: <https://newsroom.sprint.com/sprint-unveils-5G-ready-massive-MIMO-markets.htm>.
- [35] X. Chen, Z. Zhang, C. Zhong, R. Jia, and D. W. K. Ng, “Fully non-orthogonal communication for massive access,” *IEEE Trans. Commun.*, vol. 66, no. 4, pp. 1717–1731, Apr. 2018.
- [36] H. V. Cheng, E. Björnson, and E. G. Larsson, “Performance analysis of NOMA in training-based multiuser MIMO systems,” *IEEE Trans. Wireless Commun.*, vol. 17, no. 1, pp. 372–385, Jan. 2018.
- [37] D. P. Kudathanthirige and G. Amarasuriya Aruma Baduge, “NOMA-aided multi-cell downlink massive MIMO,” *IEEE J. Sel. Topic Signal Processing.*, Feb. 2019.
- [38] X. Chen, F. Gong, G. Li, H. Zhang, and P. Song, “User pairing and pair scheduling in massive MIMO-NOMA systems,” *IEEE Commun. Lett.*, vol. 22, no. 4, pp. 788–791, Apr. 2018.
- [39] C. Xu, Y. Hu, C. Liang, J. Ma, and L. Ping, “Massive MIMO, non-orthogonal multiple access and interleave division multiple access,” *IEEE Access*, vol. 5, pp. 14728–14748, Aug. 2017.
- [40] L. Liu, C. Yuen, Y. L. Guan, Y. Li, and C. Huang, “Gaussian message passing for overloaded massive MIMO-NOMA,” *IEEE Trans. Wireless Commun.*, vol. 18, no. 1, pp. 210–226, Jan. 2019.
- [41] X. Liu, Y. Liu, X. Wang, and H. Lin, “Highly efficient 3-D resource allocation techniques in 5G for NOMA-enabled massive MIMO and relaying systems,” *IEEE J. Sel. Areas Commun.*, vol. 35, no. 12, pp. 2785–2797, Dec. 2017.
- [42] J. Ma, C. Liang, C. Xu, and L. Ping, “On orthogonal and superimposed pilot schemes in massive MIMO NOMA systems,” *IEEE J. Sel. Areas Commun.*, vol. 35, no. 12, pp. 2696–2707, Dec. 2017.
- [43] Y. Li and G. Amarasuriya Aruma Baduge, “NOMA-aided cell-free massive MIMO systems,” *IEEE Wireless Commun. Lett.*, vol. 7, no. 6, pp. 950–953, Dec. 2018.
- [44] Y. Li and G. Amarasuriya Aruma Baduge, “NOMA-aided massive MIMO downlink with distributed antenna arrays,” in *Proc. IEEE ICC*, May 2019, pp. 1–7.
- [45] S. Kusaladharma, W. P. Zhu, W. Ajib, and G. Amarasuriya Aruma Baduge, “Achievable rate analysis of NOMA in cell-free massive MIMO: A stochastic geometry approach,” in *Proc. IEEE ICC*, May 2019, pp. 1–7.
- [46] S. C. R. Gaddam, D. Kudathanthirige, and G. Amarasuriya Aruma Baduge, “Achievable rate analysis for NOMA-aided massive MIMO uplink,” in *Proc. IEEE ICC*, May 2019, pp. 1–7.
- [47] S. Silva, G. Amarasuriya Aruma Baduge, C. Tellambura, and M. Ardakani, “NOMA-aided multi-way massive MIMO relay networks,” in *Proc. IEEE ICC*, May 2019, pp. 1–7.
- [48] D. Aravinda and G. Amarasuriya Aruma Baduge, “Cell-free massive MIMO with underlay spectrum-sharing,” in *Proc. IEEE ICC*, May 2019, pp. 1–7.
- [49] Y. Li and G. Amarasuriya Aruma Baduge, “Underlay spectrum-sharing massive MIMO NOMA,” *IEEE Commun. Lett.*, vol. 23, no. 1, pp. 116–119, Jan. 2019.
- [50] D. Zhang, Y. Liu, Z. Ding, Z. Zhou, A. Nallanathan, and T. Sato, “Performance analysis of non-regenerative massive-MIMO-NOMA relay systems for 5G,” *IEEE Trans. Commun.*, vol. 65, no. 11, pp. 4777–4790, Nov. 2017.
- [51] X. Chen, R. Jia, and D. W. K. Ng, “The application of relay to massive non-orthogonal multiple access,” *IEEE Trans. Commun.*, vol. 66, no. 11, pp. 5168–5180, Nov. 2018.
- [52] Y. Li and G. Amarasuriya Aruma Baduge, “Relay-aided massive MIMO NOMA downlink,” in *Proc. IEEE GLOBECOM*, Dec. 2018, pp. 1–7.
- [53] E. Björnson, J. Hoydis, and L. Sanguinetti, “Massive MIMO has unlimited capacity,” *IEEE Trans. Commun.*, vol. 17, no. 1, pp. 574–590, Jan. 2018.
- [54] C. D. Ho, H. Q. Ngo, M. Matthaiou, and L. D. Nguyen, “Power allocation for multi-way massive MIMO relaying,” *IEEE Trans. Commun.*, vol. 66, no. 10, pp. 4457–4472, Oct. 2018.
- [55] S. Rangan, T. S. Rappaport, and E. Erkip, “Millimeter-wave cellular wireless networks: Potentials and challenges,” *Proc. IEEE*, vol. 102, no. 3, pp. 366–385, Mar. 2014.
- [56] T. S. Rappaport, S. Sun, R. Mayzus, H. Zhao, Y. Azar, K. Wang, G. N. Wong, J. K. Schulz, M. Samimi, and F. Gutierrez, “Millimeter wave mobile communications for 5G cellular: It will work!” *IEEE Access*, vol. 1, pp. 335–349, 2013.
- [57] X. Zhang, A. Molisch, and S. Y. Kung, “Variable-phase-shift-based RF-baseband codesign for MIMO antenna selection,” *IEEE Trans. Signal Process.*, vol. 53, no. 11, pp. 4091–4103, Nov. 2005.
- [58] P. Sudarshan, N. B. Mehta, A. F. Molisch, and J. Zhang, “Channel statistics-based RF pre-processing with antenna selection,” *IEEE Trans. Wireless Commun.*, vol. 5, no. 12, pp. 3501–3511, Dec. 2006.
- [59] S. Han, I. Chih-lin, Z. Xu, and C. Rowell, “Large-scale antenna systems with hybrid analog and digital beamforming for millimeter wave 5G,” *IEEE Commun. Mag.*, vol. 53, no. 1, pp. 186–194, Jan. 2015.
- [60] F. Sahrabi and W. Yu, “Hybrid digital and analog beamforming design for large-scale antenna arrays,” *IEEE J. Sel. Topic Signal Processing.*, vol. 10, no. 3, pp. 501–513, Apr. 2016.
- [61] B. Wang, L. Dai, Z. Wang, N. Ge, and S. Zhou, “Spectrum and energy-efficient beamspace MIMO-NOMA for millimeter-wave communications using lens antenna array,” *IEEE J. Sel. Areas Commun.*, vol. 35, no. 10, pp. 2370–2382, Oct. 2017.
- [62] Z. Wei, L. Zhao, J. Guo, D. W. K. Ng, and J. Yuan, “A multi-beam NOMA framework for hybrid mmWave systems,” in *Proc. IEEE ICC*, May 2018, pp. 1–7.
- [63] D. Zhang, Z. Zhou, C. Xu, Y. Zhang, J. Rodriguez, and T. Sato, “Capacity analysis of NOMA with mmWave massive MIMO systems,” *IEEE J. Sel. Areas Commun.*, vol. 35, no. 7, pp. 1606–1618, Jul. 2017.
- [64] Z. Ding and H. V. Poor, “Design of massive-MIMO-NOMA with limited feedback,” *IEEE Signal Process. Lett.*, vol. 23, no. 5, pp. 629–633, May 2016.
- [65] Z. Ding, L. Dai, R. Schober, and H. V. Poor, “NOMA meets finite resolution analog beamforming in massive MIMO and millimeter-wave networks,” *IEEE Commun. Lett.*, vol. 21, no. 8, pp. 1879–1882, Aug. 2017.
- [66] M. A. Almasi, M. Vaezi, and H. Mehrpouyan, “Impact of beam misalignment on hybrid beamforming NOMA for mmWave communications,” *IEEE Trans. Commun.*, vol. 67, no. 6, pp. 4505–4518, Jun. 2019.

- [67] M. A. Almasi, R. Amiri, M. Vaezi, and H. Mehrpouyan, "Lens-based millimeter wave reconfigurable antenna NOMA," in *Proc. IEEE ICC Wkshps*, May 2019, pp. 1–6.
- [68] Z. Wei, L. Zhao, J. Guo, D. W. K. Ng, and J. Yuan, "Multi-beam NOMA for hybrid mmWave systems," *IEEE Trans. Commun.*, vol. 67, no. 2, pp. 1705–1719, Feb. 2019.
- [69] Z. Wei, D. W. Kwan Ng, and J. Yuan, "NOMA for hybrid mmWave communication systems with beamwidth control," *IEEE J. Sel. Topic Signal Processing.*, vol. 13, no. 3, pp. 567–583, Jun. 2019.
- [70] J. Brady, N. Behdad, and A. Sayeed, "Beamspace MIMO for millimeter-wave communications: System architecture, modeling, analysis, and measurements," *IEEE Trans. Antennas Propag.*, vol. 61, no. 7, pp. 3814–3827, Jul. 2013.
- [71] J. Zhao, F. Gao, W. Jia, S. Zhang, S. Jin, and H. Lin, "Angle domain hybrid precoding and channel tracking for millimeter wave massive MIMO systems," *IEEE Trans. Commun.*, vol. 16, no. 10, pp. 6868–6880, Oct. 2017.
- [72] H. Lin, F. Gao, S. Jin, and G. Y. Li, "A new view of multi-user hybrid massive MIMO: Non-orthogonal angle division multiple access," *IEEE J. Sel. Areas Commun.*, vol. 35, no. 10, pp. 2268–2280, Oct. 2017.
- [73] D. Fan, F. Gao, G. Wang, Z. Zhong, and A. Nallanathan, "Angle domain signal processing-aided channel estimation for indoor 60-GHz TDD/FDD massive MIMO systems," *IEEE J. Sel. Areas Commun.*, vol. 35, no. 9, pp. 1948–1961, Sep. 2017.
- [74] H. L. V. Trees, *Optimum Array Processing: Part IV of Detection, Estimation, and Modulation Theory*. John Wiley and Sons, Inc., New York, 2002.
- [75] Z. Ding, M. Peng, and H. V. Poor, "Cooperative non-orthogonal multiple access in 5G systems," *IEEE Commun. Lett.*, vol. 19, no. 8, pp. 1462–1465, 2015.
- [76] Y. Liu, Z. Ding, M. ElKashlan, and H. V. Poor, "Cooperative non-orthogonal multiple access with simultaneous wireless information and power transfer," *IEEE J. Sel. Areas Commun.*, vol. 34, no. 4, pp. 938–953, Apr. 2016.
- [77] C. Zhong and Z. Zhang, "Non-orthogonal multiple access with cooperative full-duplex relaying," *IEEE Commun. Lett.*, vol. 20, no. 12, pp. 2478–2481, Dec. 2016.
- [78] Z. Zhang, Z. Ma, M. Xiao, Z. Ding, and P. Fan, "Full-duplex device-to-device-aided cooperative nonorthogonal multiple access," *IEEE Trans. Veh. Technol.*, vol. 66, no. 5, pp. 4467–4471, May 2017.
- [79] X. Yue, Y. Liu, S. Kang, A. Nallanathan, and Z. Ding, "Exploiting full/half-duplex user relaying in NOMA systems," *IEEE Trans. Commun.*, vol. 66, no. 2, pp. 560–575, Feb. 2018.
- [80] M. S. Elbamy, M. Bennis, W. Saad, M. Debbah, and M. Latva-aho, "Resource optimization and power allocation in in-band full duplex-enabled non-orthogonal multiple access networks," *IEEE J. Sel. Areas Commun.*, vol. 35, no. 12, pp. 2860–2873, Dec. 2017.
- [81] Z. Ding, H. Dai, and H. V. Poor, "Relay selection for cooperative NOMA," *IEEE Wireless Commun. Lett.*, vol. 5, no. 4, pp. 416–419, Aug. 2016.
- [82] J. Men and J. Ge, "Non-orthogonal multiple access for multiple-antenna relaying networks," *IEEE Commun. Lett.*, vol. 19, no. 10, pp. 1686–1689, Oct. 2015.
- [83] W. Shin, H. Yang, M. Vaezi, J. Lee, and H. V. Poor, "Relay-aided NOMA in uplink cellular networks," *IEEE Signal Process. Lett.*, vol. 24, no. 12, pp. 1842–1846, Dec. 2017.
- [84] J. B. Kim and I. H. Lee, "Non-orthogonal multiple access in coordinated direct and relay transmission," *IEEE Commun. Lett.*, vol. 19, no. 11, pp. 2037–2040, Nov. 2015.
- [85] X. Yue, Y. Liu, S. Kang, A. Nallanathan, and Y. Chen, "Modeling and analysis of two-way relay non-orthogonal multiple access systems," *IEEE Trans. Commun.*, vol. 66, no. 9, pp. 3784–3796, Sep. 2018.
- [86] W. Shin, M. Vaezi, B. Lee, D. J. Love, J. Lee, and H. V. Poor, "Coordinated beamforming for multi-cell MIMO-NOMA," *IEEE Commun. Lett.*, vol. 21, no. 1, pp. 84–87, Jan. 2017.
- [87] Y. Liu, Z. Qin, M. ElKashlan, A. Nallanathan, and J. A. McCann, "Non-orthogonal multiple access in large-scale heterogeneous networks," *IEEE J. Sel. Areas Commun.*, vol. 35, no. 12, pp. 2667–2680, Dec. 2017.
- [88] F. Zhou, Y. Wu, R. Q. Hu, Y. Wang, and K. K. Wong, "Energy-efficient NOMA enabled heterogeneous cloud radio access networks," *IEEE Network*, vol. 32, no. 2, pp. 152–160, March 2018.
- [89] M. S. Ali, E. Hossain, and D. I. Kim, "Coordinated multipoint transmission in downlink multi-cell NOMA systems: Models and spectral efficiency performance," *IEEE Wireless Commun.*, vol. 25, no. 2, pp. 24–31, April 2018.
- [90] Y. Liu, H. Xing, C. Pan, A. Nallanathan, M. ElKashlan, and L. Hanzo, "Multiple-antenna-assisted non-orthogonal multiple access," *IEEE Wireless Commun.*, vol. 25, no. 2, pp. 17–23, April 2018.
- [91] W. Shin, M. Vaezi, J. Lee, and H. V. Poor, "On the number of users served in MIMO-NOMA cellular networks," in *Proc. IEEE ISWCS*, 2016, pp. 638–642.
- [92] X. Gu, X. Ji, Z. Ding, W. Wu, and M. Peng, "Outage probability analysis of non-orthogonal multiple access in cloud radio access networks," *IEEE Commun. Lett.*, vol. 22, no. 1, pp. 149–152, Jan. 2018.
- [93] Z. Qin, X. Yue, Y. Liu, Z. Ding, and A. Nallanathan, "User association and resource allocation in unified NOMA enabled heterogeneous ultra dense networks," *IEEE Commun. Mag.*, vol. 56, no. 6, pp. 86–92, June 2018.
- [94] L. Dai, B. Wang, Y. Yuan, S. Han, C. I. I, and Z. Wang, "Non-orthogonal multiple access for 5G: solutions, challenges, opportunities, and future research trends," *IEEE Commun. Mag.*, vol. 53, no. 9, pp. 74–81, Sep. 2015.
- [95] M. Jiang, Y. Li, Q. Zhang, Q. Li, and J. Qin, "Secure beamforming in downlink MIMO nonorthogonal multiple access networks," *IEEE Signal Process. Lett.*, vol. 24, no. 12, pp. 1852–1856, 2017.
- [96] J. Mitola, "Cognitive radio—an integrated agent architecture for software defined radio," 2000.
- [97] A. Goldsmith, S. A. Jafar, I. Maric, and S. Srinivasa, "Breaking spectrum gridlock with cognitive radios: An information theoretic perspective," *Proc. IEEE*, vol. 97, no. 5, pp. 894–914, May 2009.
- [98] M. Vaezi, "The capacity of more capable cognitive interference channels," in *Proc. IEEE Allerton*, 2014, pp. 372–377.
- [99] Y. Liu, S. A. Mousavifar, Y. Deng, C. Leung, and M. ElKashlan, "Wireless energy harvesting in a cognitive relay network," *IEEE Trans. Wireless Commun.*, vol. 15, no. 4, pp. 2498–2508, Apr. 2016.
- [100] Z. Qin, Y. Liu, Y. Gao, M. ElKashlan, and A. Nallanathan, "Wireless powered cognitive radio networks with compressive sensing and matrix completion," *IEEE Trans. Commun.*, vol. 65, no. 4, pp. 1464–1476, Apr. 2017.
- [101] Z. Qin, J. Fan, Y. Liu, Y. Gao, and G. Y. Li, "Sparse representation for wireless communications: A compressive sensing approach," *IEEE Signal Process. Mag.*, vol. 35, no. 3, pp. 40–58, May 2018.
- [102] Y. Liu, Z. Ding, M. ElKashlan, and J. Yuan, "Non-orthogonal multiple access in large-scale underlay cognitive radio networks," *IEEE Trans. Veh. Technol.*, vol. 65, no. 12, pp. 10152–10157, Dec. 2016.
- [103] L. Lv, J. Chen, Q. Ni, and Z. Ding, "Design of cooperative non-orthogonal multicast cognitive multiple access for 5G systems: User scheduling and performance analysis," *IEEE Trans. Commun.*, vol. 65, no. 6, pp. 2641–2656, June 2017.
- [104] L. Lv, L. Yang, H. Jiang, T. H. Luan, and J. Chen, "When NOMA meets multiuser cognitive radio: Opportunistic cooperation and user scheduling," *IEEE Trans. Veh. Technol.*, vol. 67, no. 7, pp. 6679–6684, July 2018.
- [105] Z. Ding, P. Fan, and H. V. Poor, "Impact of user pairing on 5G non-orthogonal multiple access," *IEEE Trans. Veh. Technol.*, vol. 65, no. 8, pp. 6010–6023, Aug. 2016.
- [106] Z. Yang, Z. Ding, P. Fan, and N. Al-Dahhir, "A general power allocation scheme to guarantee quality of service in downlink and uplink NOMA systems," *IEEE Trans. Wireless Commun.*, vol. 15, no. 11, pp. 7244–7257, Nov. 2016.
- [107] Z. Ding, L. Dai, and H. V. Poor, "MIMO-NOMA design for small packet transmission in the Internet of Things," *IEEE Access*, vol. 4, pp. 1393–1405, 2016.
- [108] Z. Qin, H. Ye, G. Y. Li, and B. F. Juang, "Deep learning in physical layer communications," *IEEE Wireless Commun.*, vol. 26, no. 2, pp. 93–99, Apr. 2019.
- [109] Y. Liu, S. Bi, Z. Shi, and L. Hanzo, "When machine learning meets big data: A wireless communication perspective," *arXiv:1901.08329*, 2019.
- [110] Z. Qin, F. Y. Li, G. Y. Li, J. A. McCann, and Q. Ni, "Low-power wide-area networks for sustainable IoT," *IEEE Wireless Commun.*, pp. 1–6, 2019.
- [111] F. Cui, Z. Qin, Y. Cai, M. Zhao, and G. Y. Li, "Rethinking outage constraints for resource management in NOMA networks," *IEEE J. Sel. Topic Signal Processing.*, vol. 13, no. 3, pp. 423–435, Jun. 2019.
- [112] Y. Liu, Z. Qin, Y. Cai, Y. Gao, G. Y. Li, and A. Nallanathan, "UAV communications based on non-orthogonal multiple access," *IEEE Wireless Commun.*, vol. 26, no. 1, pp. 52–57, Feb. 2019.
- [113] L. Liang, H. Ye, and G. Y. Li, "Spectrum sharing in vehicular networks based on multi-agent reinforcement learning," *arXiv preprint arXiv:1905.02910*, 2019.

- [114] S. Goel and R. Negi, "Guaranteeing secrecy using artificial noise," *IEEE Trans. Wireless Commun.*, vol. 7, no. 6, 2008.
- [115] S. A. A. Fakoorian and A. L. Swindlehurst, "Optimal power allocation for GSVD-based beamforming in the MIMO Gaussian wiretap channel," in *Proc. IEEE ISIT*, 2012, pp. 2321–2325.
- [116] S. Shafiee, N. Liu, and S. Ulukus, "Towards the secrecy capacity of the Gaussian MIMO wire-tap channel: The 2-2-1 channel," *IEEE Trans. Inf. Theory*, vol. 55, no. 9, pp. 4033–4039, 2009.
- [117] M. Vaezi, W. Shin, H. V. Poor, and J. Lee, "MIMO Gaussian wiretap channels with two transmit antennas: Optimal precoding and power allocation," in *Proc. IEEE ISIT*, 2017, pp. 1708–1712.
- [118] M. Vaezi, W. Shin, and H. V. Poor, "Optimal beamforming for Gaussian MIMO wiretap channels with two transmit antennas," *IEEE Trans. Wireless Commun.*, vol. 16, no. 10, pp. 6726–6735, October 2017.
- [119] N. S. Ferdinand, D. B. da Costa, and M. Latva-aho, "Effects of outdated CSI on the secrecy performance of MISO wiretap channels with transmit antenna selection," *IEEE Commun. Lett.*, vol. 17, no. 5, pp. 864–867, 2013.
- [120] N. Yang, P. L. Yeoh, M. ElKashlan, R. Schober, and I. B. Collings, "Transmit antenna selection for security enhancement in MIMO wiretap channels," *IEEE Trans. Commun.*, vol. 61, no. 1, pp. 144–154, 2013.
- [121] H. Alves, R. D. Souza, M. Debbah, and M. Bennis, "Performance of transmit antenna selection physical layer security schemes," *IEEE Signal Process. Lett.*, vol. 19, no. 6, pp. 372–375, 2012.
- [122] L. Dong, Z. Han, A. P. Petropulu, and H. V. Poor, "Improving wireless physical layer security via cooperating relays," *IEEE Trans. Signal Process.*, vol. 58, no. 3, pp. 1875–1888, 2010.
- [123] C. Jeong and I.-M. Kim, "Optimal power allocation for secure multicarrier relay systems," *IEEE Trans. Signal Process.*, vol. 59, no. 11, pp. 5428–5442, 2011.
- [124] J. Li, A. P. Petropulu, and S. Weber, "On cooperative relaying schemes for wireless physical layer security," *IEEE Trans. Signal Process.*, vol. 59, no. 10, pp. 4985–4997, 2011.
- [125] M. Vaezi and H. V. Poor, "NOMA: An Information-Theoretic Perspective," in *Multiple Access Techniques for 5G Wireless Networks and Beyond*. Springer, 2019, pp. 167–193.
- [126] L. Lv, Z. Ding, Q. Ni, and J. Chen, "Secure MISO-NOMA transmission with artificial noise," *IEEE Trans. Veh. Technol.*, vol. 67, no. 7, pp. 6700–6705, 2018.
- [127] F. Zhou, Z. Chu, H. Sun, R. Q. Hu, and L. Hanzo, "Artificial noise aided secure cognitive beamforming for cooperative MISO-NOMA using SWIPT," *IEEE J. Sel. Areas Commun.*, vol. 36, no. 4, pp. 918–931, 2018.
- [128] M. Zeng, P. Nguyen, O. Dobre, and H. V. Poor, "Securing downlink massive MIMO NOMA networks with artificial noise," *IEEE J. Sel. Topic Signal Processing.*, 2019.
- [129] Y. Liu, Z. Qin, M. ElKashlan, Y. Gao, and L. Hanzo, "Enhancing the physical layer security of non-orthogonal multiple access in large-scale networks," *IEEE Trans. Wireless Commun.*, vol. 16, no. 3, pp. 1656–1672, 2017.
- [130] B. Zheng, M. Wen, C.-X. Wang, X. Wang, F. Chen, J. Tang, and F. Ji, "Secure NOMA based two-way relay networks using artificial noise and full duplex," *IEEE J. Sel. Areas Commun.*, vol. 36, no. 7, pp. 1426–1440, 2018.
- [131] A. Arafa, W. Shin, M. Vaezi, and H. V. Poor, "Secure relaying in non-orthogonal multiple access: Trusted and untrusted scenarios," *arXiv preprint arXiv:1808.07864*, 2018.
- [132] Z. Xiang, W. Yang, G. Pan, Y. Cai, and Y. Song, "Physical layer security in cognitive radio inspired NOMA network," *IEEE J. Sel. Topic Signal Processing.*, vol. 13, no. 3, pp. 700–714, 2019.
- [133] C. Yuan, X. Tao, N. Li, W. Ni, R. P. Liu, and P. Zhang, "Analysis on secrecy capacity of cooperative non-orthogonal multiple access with proactive jamming," *IEEE Trans. Veh. Technol.*, 2019.
- [134] Z. Xiang, W. Yang, G. Pan, Y. Cai, and X. Sun, "Secure transmission in non-orthogonal multiple access networks with an untrusted relay," *IEEE Wireless Commun. Lett.*, 2019.
- [135] H. Lei, J. Zhang, K.-H. Park, P. Xu, I. S. Ansari, G. Pan, B. Alomair, and M.-S. Alouini, "On secure NOMA systems with transmit antenna selection schemes," *IEEE Access*, vol. 5, pp. 17450–17464, 2017.
- [136] H. Lei, J. Zhang, K.-H. Park, P. Xu, Z. Zhang, G. Pan, and M.-S. Alouini, "Secrecy outage of Max–Min TAS scheme in MIMO-NOMA systems," *IEEE Trans. Veh. Technol.*, vol. 67, no. 8, pp. 6981–6990, 2018.
- [137] J. Chen, L. Yang, and M.-S. Alouini, "Physical layer security for cooperative NOMA systems," *IEEE Trans. Veh. Technol.*, vol. 67, no. 5, pp. 4645–4649, 2018.
- [138] A. Arafa, W. Shin, M. Vaezi, and H. V. Poor, "Securing downlink non-orthogonal multiple access systems by trusted relays," in *Proc. IEEE GLOBECOM*, 2018, pp. 1–5.
- [139] —, "Downlink non-orthogonal multiple access systems with an untrusted relay," in *Proc. IEEE ACSSC*, 2018.
- [140] A. Arafa, E. Panayirci, and H. V. Poor, "Relay-aided secure broadcasting for visible light communications," *IEEE Trans. Commun.*, vol. 67, 2019.
- [141] K. Wang, X. Wang, and X. Zhang, "SLNR-based transmit beamforming for MIMO wiretap channel," *Wireless Personal Communications*, vol. 71, no. 1, pp. 109–121, 2013.
- [142] A. Khisti and G. W. Wornell, "Secure transmission with multiple antennas I: The MISOME wiretap channel," *IEEE Trans. Inf. Theory*, vol. 56, no. 7, pp. 3088–3104, 2010.
- [143] X. Zhang, Y. Qi, and M. Vaezi, "A rotation-based method for precoding in Gaussian MIMOME channels," submitted for publication, 2019.
- [144] Y. Liu, Z. Ding, M. ElKashlan, and H. V. Poor, "Cooperative non-orthogonal multiple access with simultaneous wireless information and power transfer," *IEEE J. Sel. Areas Commun.*, vol. 34, no. 4, pp. 938–953, April 2016.
- [145] R. Sun, Y. Wang, X. Wang, and Y. Zhang, "Transceiver design for cooperative nonorthogonal multiple access systems with wireless energy transfer," *IET Commun.*, vol. 10, no. 15, pp. 1947–1955, October 2016.
- [146] N. T. Do, D. B. da Costa, T. Q. Duong, and B. An, "A BNBF user selection scheme for NOMA-based cooperative relaying systems with SWIPT," *IEEE Commun. Lett.*, vol. 21, no. 3, pp. 664–667, March 2017.
- [147] Y. Xu, C. Shen, Z. Ding, X. Sun, S. Yan, and G. Zhu, "Joint beamforming design and power splitting control in cooperative SWIPT NOMA systems," in *Proc. IEEE ICC*, May 2017.
- [148] Y. Ye, Y. Li, D. Wang, and G. Lu, "Power splitting protocol design for the cooperative NOMA with SWIPT," in *Proc. IEEE ICC*, May 2017.
- [149] M. Ashraf, A. Shahid, J. W. Jang, and K.-G. Lee, "Energy harvesting non-orthogonal multiple access system with multi-antenna relay and base station," *IEEE Access*, vol. 5, pp. 17 660–17 670, September 2017.
- [150] T. N. Do, D. B. da Costa, T. Q. Duong, and B. An, "Improving the performance of cell-edge users in MISO-NOMA systems using TAS and SWIPT-based cooperative transmissions," *IEEE Trans. Green Commun. Netw.*, vol. 2, no. 1, pp. 49–61, March 2018.
- [151] Y. Alsaba, C. Y. Leow, and S. K. A. Rahim, "Full-duplex cooperative non-orthogonal multiple access with beamforming and energy harvesting," *IEEE Access*, vol. 6, pp. 19726–19738, April 2018.
- [152] P. D. Diamantoulakis, K. N. Pappi, Z. Ding, and G. K. Karagiannidis, "Wireless-powered communications with non-orthogonal multiple access," *IEEE Trans. Wireless Commun.*, vol. 15, no. 12, pp. 8422–8436, December 2016.
- [153] M. Song and M. Zheng, "Energy efficiency optimization for wireless powered sensor networks with nonorthogonal multiple access," *IEEE Sens. Lett.*, vol. 2, no. 1, March 2018.
- [154] L. Pei, Z. Yang, C. Pan, W. Huang, M. Chen, M. ElKashlan, and A. Nallanathan, "Energy-efficient D2D communications underlying NOMA-based networks with energy harvesting," *IEEE Commun. Lett.*, vol. 22, no. 5, pp. 914–917, May 2018.
- [155] T. A. Zewde and M. C. Gurosy, "NOMA-based energy-efficient wireless powered communications," *IEEE Trans. Green Commun. Netw.*, vol. 2, no. 3, pp. 679–692, September 2018.
- [156] Z. Yang, W. Xu, Y. Pan, C. Pan, and M. Chen, "Energy efficient resource allocation in machine-to-machine communications with multiple access and energy harvesting for IoT," *IEEE Internet Things J.*, vol. 5, no. 1, pp. 229–245, February 2018.
- [157] Q. Wu, W. Chen, D. W. K. Ng, and R. Schober, "Spectral and energy-efficient wireless powered IoT networks: NOMA or TDMA?" *IEEE Trans. Veh. Technol.*, vol. 67, no. 7, pp. 6663–6667, July 2018.
- [158] W. Han, J. Ge, and J. Men, "Performance analysis for NOMA energy harvesting relaying networks with transmit antenna selection and maximal-ratio combining over Nakagami-m fading," *IET Commun.*, vol. 10, no. 18, pp. 2687–2693, December 2016.
- [159] Z. Yang, Z. Ding, P. Fan, and N. Al-Dhahir, "The impact of power allocation on cooperative non-orthogonal multiple access networks with SWIPT," *IEEE Trans. Wireless Commun.*, vol. 16, no. 7, pp. 4332–4343, July 2017.
- [160] Y. Zhang and J. Ge, "Performance analysis for non-orthogonal multiple access in energy harvesting relaying networks," *IET Commun.*, vol. 11, no. 11, pp. 1768–1774, August 2017.
- [161] L. T. Dung, T. M. Hoang, N. T. Tan, and S.-G. Choi, "Analysis of partial relay selection in NOMA systems with RF energy harvesting," in *Proc. SigTelCom*, January 2018.

- [162] D. H. Do, M. Vaezi, and T. L. Nguyen, "Wireless powered cooperative relaying using NOMA with imperfect CSI," in *Proc. IEEE GLOBECOM Wkshps*, 2018, pp. 1–5.
- [163] Y. Zhang and J. Ge, "Impact analysis for user pairing on NOMA-based energy harvesting relaying networks with imperfect CSI," *IET Commun.*, vol. 12, no. 13, pp. 1609–1614, August 2018.
- [164] D.-B. Ha and S. Q. Nguyen, "Outage performance of energy harvesting DF relaying NOMA networks," *Mobile Netw. Appl.*, vol. 23, no. 6, pp. 1572–1585, December 2018.
- [165] M. F. Kader, M. B. Shahab, and S. Y. Shin, "Cooperative spectrum sharing with energy harvesting best secondary user selection and non-orthogonal multiple access," in *Proc. IEEE ICNC*, January 2017.
- [166] Y. Wang, Y. Wu, F. Zhou, Z. Chu, Y. Wu, and F. Yuan, "Multi-objective resource allocation in a NOMA cognitive radio network with a practical non-linear energy harvesting model," *IEEE Access*, vol. 6, pp. 12 973–12 982, March 2018.
- [167] Y. Zhao, J. Hu, Z. Ding, and K. Yang, "Constellation rotation aided modulation design for the multi-user SWIPT-NOMA," in *Proc. IEEE ICC*, May 2018.
- [168] B. Xu, Y. Chen, J. R. Carrión, and T. Zhang, "Resource allocation in energy-cooperation enabled two-tier NOMA HetNets toward green 5G," *IEEE J. Sel. Areas Commun.*, vol. 35, no. 12, pp. 2758–2770, December 2017.
- [169] B. Clerckx, R. Zhang, R. Schober, D. W. K. Ng, D. I. Kim, and H. V. Poor, "Fundamentals of wireless information and power transfer: From rf energy harvester models to signal and system designs," *IEEE J. Sel. Areas Commun.*, vol. 37, no. 1, pp. 4–33, January 2019.
- [170] W. Shin, M. Vaezi, J. Lee, and H. V. Poor, "Cooperative wireless powered communication networks with interference harvesting," *IEEE Trans. Veh. Technol.*, vol. 67, no. 4, pp. 3701–3705, 2017.
- [171] R. C. Kizilirmak, C. R. Rowell, and M. Uysal, "Non-orthogonal multiple access (NOMA) for indoor visible light communications," in *Proc. IWOW*, September 2015.
- [172] X. Zhang, Q. Gao, C. Gong, and Z. Xu, "User grouping and power allocation for NOMA visible light communication multi-cell networks," *IEEE Commun. Lett.*, vol. 21, no. 4, pp. 777–780, April 2017.
- [173] H. Marshoud, V. M. Kapinas, G. K. Karagiannidis, and S. Muhaidat, "Non-orthogonal multiple access for visible light communications," *IEEE Photon. Technol. Lett.*, vol. 28, no. 1, pp. 51–54, January 2016.
- [174] L. Yin, W. O. Popoola, X. Wu, and H. Haas, "Performance evaluation of non-orthogonal multiple access in visible light communication," *IEEE Trans. Commun.*, vol. 64, no. 12, pp. 5162–5175, December 2016.
- [175] C. Chen, W.-D. Zhong, and H. Yang, "On the performance of MIMO-NOMA-based visible light communication systems," *IEEE Photon. Technol. Lett.*, vol. 30, no. 4, pp. 307–310, February 2018.
- [176] R. Mitra and V. Bhatia, "Precoded Chebyshev-NLMS-based pre-distorter for nonlinear LED compensation in NOMA-VLC," *IEEE Trans. Commun.*, vol. 65, no. 11, pp. 4845–4856, November 2017.
- [177] Z. Yang, W. Xu, and Y. Li, "Fair non-orthogonal multiple access for visible light communication downlinks," *IEEE Wireless Commun. Lett.*, vol. 6, no. 1, pp. 66–69, February 2017.
- [178] H. Marshoud, P. C. Sofotasios, S. Muhaidat, G. K. Karagiannidis, and B. S. Sharif, "On the performance of visible light communication systems with non-orthogonal multiple access," *IEEE Trans. Wireless Commun.*, vol. 16, no. 10, pp. 6350–6364, October 2017.
- [179] Y. Yapici and I. Guvenc, "Non-orthogonal multiple access for mobile VLC networks with random receiver orientation," arXiv:1801.04888.
- [180] S. Ma, Y. He, H. Li, S. Lu, F. Zhang, and S. Li, "Optimal power allocation for mobile users in non-orthogonal multiple access visible light communication networks," *IEEE Trans. Commun.*, to appear.
- [181] B. Lin, W. Ye, X. Tang, and Z. Ghassemlooy, "Experimental demonstration of bidirectional NOMA-OFDMA visible light communications," *Optics Express*, vol. 25, no. 4, pp. 4348–4355, February 2017.
- [182] H. Li, Z. Huang, Y. Xiao, S. Zhan, and Y. Ji, "Solution for error propagation in a NOMA-based VLC network: symmetric superposition coding," *Optics Express*, vol. 25, no. 24, pp. 29 856–29 863, November 2017.
- [183] Z. Ding, P. Fan, and H. V. Poor, "Impact of non-orthogonal multiple access on the offloading of mobile edge computing," *IEEE Trans. Commun.*, vol. 67, no. 1, pp. 375–390, Jan. 2019.
- [184] F. Wang, J. Xu, and Z. Ding, "Multi-antenna NOMA for computation offloading in multiuser mobile edge computing systems," *IEEE Trans. Commun.*, vol. 67, no. 3, pp. 2450–2463, Mar. 2019.
- [185] Z. Ding, J. Xu, O. A. Dobre, and H. V. Poor, "Joint power and time allocation for NOMA-MEC offloading," *Submitted to IEEE Wireless Commun. Lett.*, 2018.
- [186] A. Kiani and N. Ansari, "Edge computing aware NOMA for 5G networks," *IEEE Internet Things*, vol. 5, no. 2, pp. 1299–1306, Apr. 2018.
- [187] Z. Ding, D. W. K. Ng, R. Schober, and H. V. Poor, "Delay minimization for NOMA-MEC offloading," *IEEE Signal Process. Lett.*, vol. 25, no. 12, pp. 1875–1879, Dec. 2018.
- [188] F. Fang, Y. Xu, Z. Ding, C. Shen, M. Peng, and G. K. Karagiannidis, "Optimal task assignment and power allocation for NOMA mobile-edge computing networks," arXiv:1904.12389.
- [189] Q. Gu, G. Wang, J. Liu, R. Fan, D. Fan, and Z. Zhong, "Optimal offloading with non-orthogonal multiple access in mobile edge computing," in *Proc. IEEE GLOBECOM*, Dec. 2018, pp. 1–5.
- [190] B. Di, L. Song, Y. Li, and Z. Han, "V2X meets NOMA: Non-orthogonal multiple access for 5G-enabled vehicular networks," *IEEE Wireless Commun.*, vol. 24, no. 6, pp. 14–21, 2017.
- [191] Q. Zhang, L. Zhang, Y.-C. Liang, and P.-Y. Kam, "Backscatter-NOMA: A symbiotic system of cellular and Internet-of-Things networks," *IEEE Access*, vol. 7, pp. 20 000–20 013, 2019.
- [192] Z. Ding, P. Fan, G. K. Karagiannidis, R. Schober, and H. V. Poor, "NOMA assisted wireless caching: Strategies and performance analysis," *IEEE Trans. Commun.*, vol. 66, no. 10, pp. 4854–4876, 2018.
- [193] K. N. Doan, W. Shin, M. Vaezi, H. V. Poor, and T. Q. Quek, "Optimal power allocation in cache-aided non-orthogonal multiple access systems," in *Proc. IEEE ICC Workshops*, 2018, pp. 1–6.
- [194] L. Xiang, D. W. K. Ng, X. Ge, Z. Ding, V. W. Wong, and R. Schober, "Cache-aided non-orthogonal multiple access: The two-user case," *IEEE J. Sel. Topic Signal Processing.*, vol. 13, no. 3, pp. 436–451, 2019.
- [195] E. Khorov, A. Kureev, and I. Levitsky, "NOMA testbed on Wi-Fi," in *Proc. IEEE PIMRC*, 2018, pp. 1153–1154.
- [196] J. Cui, Z. Ding, P. Fan, and N. Al-Dhahir, "Unsupervised machine learning-based user clustering in millimeter-wave-NOMA systems," *IEEE Trans. Wireless Commun.*, vol. 17, no. 11, pp. 7425–7440, 2018.
- [197] N. Zhang, K. Cheng, and G. Kang, "A machine-learning-based blind detection on interference modulation order in NOMA systems," *IEEE Commun. Lett.*, vol. 22, no. 12, pp. 2463–2466, 2018.
- [198] L. Xiao, Y. Li, C. Dai, H. Dai, and H. V. Poor, "Reinforcement learning-based NOMA power allocation in the presence of smart jamming," *IEEE Trans. Veh. Technol.*, vol. 67, no. 4, pp. 3377–3389, 2018.
- [199] K. D. Nguyen, M. Vaezi, W. Shin, H. V. Poor, H. Shin, and T. Q. Quek, "Power allocations in cache-aided NOMA systems: Optimization and deep learning approaches," submitted for publication, 2019.
- [200] J. Luo, J. Tang, D. So, G. Chen, K. Cumanan, and J. Chambers, "A deep learning-based approach to power minimization in multi-carrier NOMA with SWIPT," *IEEE Access*, pp. 17 450–17 460, 2019.



Mojtaba Vaezi (S'09, M'14, SM'18) received the Ph.D. degree from McGill University in 2014 and the B.Sc. and M.Sc. degrees from Amirkabir University of Technology (Tehran Polytechnic), Iran, all in Electrical Engineering. From 2015–2018 he was a Postdoctoral Research Fellow and Associate Research Scholar at Princeton University. He is currently an Assistant Professor of ECE at Villanova University. Before joining Princeton, he was a researcher at Ericsson Research in Montreal, Canada. His research interests include the broad areas of

signal processing and machine learning for wireless communications with an emphasis on physical layer security and fifth generation (5G) radio access technologies. Among his publications in these areas is the book *Multiple Access Techniques for 5G Wireless Networks and Beyond* (Springer, 2019).

Dr. Vaezi is an Editor of *IEEE Transactions on Communications* and *IEEE Communications Letters*. He has co-organized five NOMA workshops at IEEE VTC 2017-Spring, Globecom'17, 18 and ICC'18, 19. He is a recipient of several academic, leadership, and research awards, including McGill Engineering Doctoral Award, IEEE Larry K. Wilson Regional Student Activities Award in 2013, the Natural Sciences and Engineering Research Council of Canada (NSERC) Postdoctoral Fellowship in 2014, Ministry of Science and ICT of Korea's best paper award in 2017, and IEEE Communications Letters Exemplary Editor Award in 2018.



Gayan Amarasuriya Aruma Baduge received the B.Sc. degree in Engineering (with first class Hons.) from the Department of Electronics and Telecommunications Engineering, University of Moratuwa, Moratuwa, Sri Lanka, in 2006, and the Ph.D. degree in Electrical Engineering from the Department of Electrical and Computer Engineering, University of Alberta, Edmonton, AB, Canada, in 2013. He was a Postdoctoral Research Fellow with the Department of Electrical Engineering, Princeton University, Princeton, NJ, USA from 2014 to 2016. Currently,

he is an assistant professor in the Department of Electrical and Computer Engineering in Southern Illinois University, IL, USA. His research interests include massive MIMO, millimeter-wave cellular networks, non-orthogonal multiple-access, wireless energy harvesting, cooperative MIMO relay networks, cognitive spectrum sharing and physical layer security.

He is an Associate Editor for IEEE Communications Letters. He received the best paper award in Wireless Communications Symposium at IEEE Global Communications Conference, San Diego, CA, USA, Dec. 2015. He was an Exemplary Reviewer for IEEE Communication Letters in 2011, 2012 and for IEEE Wireless Communications Letters in 2013. He has served as a member of Technical Program Committees in several special issues for IEEE Journal on Selected Areas in Communications and at many IEEE conferences, including ICC, GLOBECOM, WCNC, PIMRC and VTC.

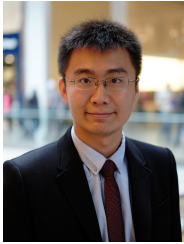

Yuanwei Liu (S'13, M'16, SM'19) received the B.S. and M.S. degrees from the Beijing University of Posts and Telecommunications in 2011 and 2014, respectively, and the Ph.D. degree in electrical engineering from the Queen Mary University of London, U.K., in 2016. He was with the Department of Informatics, Kings College London, from 2016 to 2017, where he was a Post-Doctoral Research Fellow. He has been a Lecturer (Assistant Professor) with the School of Electronic Engineering and Computer Science, Queen Mary University of London, since

2017.

His research interests include 5G and beyond wireless networks, the Internet of Things, machine learning, and stochastic geometry. He has served as a TPC Member for many IEEE conferences, such as GLOBECOM and ICC. He received the Exemplary Reviewer Certificate of IEEE WIRELESS COMMUNICATIONS LETTERS in 2015, IEEE TRANSACTIONS ON COMMUNICATIONS in 2016 and 2017, and IEEE TRANSACTIONS ON WIRELESS COMMUNICATIONS in 2017 and 2018. He has served as the Publicity Co-Chair for VTC 2019-Fall. He is currently an Editor on the Editorial Board of the IEEE TRANSACTIONS ON COMMUNICATIONS, IEEE COMMUNICATIONS LETTERS, and IEEE ACCESS. He also serves as a Guest Editor for IEEE JSTSP special issue on Signal Processing Advances for Non-Orthogonal Multiple Access in Next Generation Wireless Networks.



Ahmed Arafa (S'13–M'17) received the B.Sc. degree, with highest honors, in electrical engineering from Alexandria University, Egypt, in 2010, the M.Sc. degree in wireless technologies from the Wireless Intelligent Networks Center (WINC), Nile University, Egypt, in 2012, and the M.Sc. and Ph.D. degrees in electrical engineering from the University of Maryland at College Park, MD, USA, in 2016 and 2017, respectively. He has been a Postdoctoral Research Associate in the Electrical Engineering Department at Princeton University during

2017–2019. He is now an Assistant Professor in the Department of Electrical and Computer Engineering at the University of North Carolina at Charlotte.

Dr. Arafa's research interests are in communication theory, information theory, and networks, with recent focus on energy harvesting communications, age of information, physical layer security, non-orthogonal multiple access systems, and visible light communications. He was the recipient of the Distinguished Dissertation award from the Department of Electrical and Computer Engineering, University of Maryland, in 2017, for his Ph.D. thesis work on optimal energy management policies in energy harvesting communication networks with system costs.



Fang Fang received the B.A.Sc. and the M.A.Sc. degrees in electronic engineering from Lanzhou University in 2010 and 2013, respectively, and the Ph.D. degree in electrical engineering from the University of British Columbia (UBC), Kelowna, BC, Canada, in 2018. She is currently a Post Doctoral Research Associate with school of electrical and electronic engineering, the University of Manchester, Manchester, U.K. Her current research interests include NOMA, machine learning and mobile edge computing. She has served as a TPC member for IEEE conferences,

i.e., IEEE GLOBECOM and IEEE ICC. She received the Exemplary Reviewer Certificate of the IEEE Transactions on Communications, 2017.



Zhiguo Ding is currently a Professor in Communications at the University of Manchester. From Sept. 2012 to Sept. 2019, he has also been an academic visitor in Princeton University. Dr. Ding research interests are 5G networks, signal processing and statistical signal processing. He has been serving as an Editor for IEEE TCOM, IEEE TVT, and served as an editor for IEEE WCL and IEEE CL. He received the EU Marie Curie Fellowship 2012–2014, IEEE TVT Top Editor 2017, 2018 IEEE COMSOC Heinrich Hertz Award, 2018 IEEE VTS Jack Neubauer

Memorial Award, and 2018 IEEE SPS Best Signal Processing Letter Award.