

Deep Learning Based Single Sample Per Person Face Recognition: A Survey

Delong Chen, Fan Liu*, Zewen Li
College of Computer and Information, Hohai University
Nanjing, China
fanliu@hhu.edu.cn

Abstract—Face recognition has been an active research area in the field of pattern recognition, especially since the rise of deep learning in recent years. However, in some practical situations, each identity in the training set has only a single sample. This type of situation is called Single Sample Per Person (SSPP), which brings a great challenge to the effective training of deep models. To resolve this issue, and to unleash the full potential of deep learning, many deep learning based SSPP face recognition methods have been proposed in recent years. There have been several comprehensive surveys for traditional methods based SSPP face recognition approaches, but emerging deep learning based methods are rarely involved. In this paper, we focus on those deep methods, classifying them as virtual sample methods and generic learning methods. In virtual sample methods, virtual face images or virtual face features are generated to benefit the training of the deep model. In generic learning methods, additional multi-sample generic set are used. Efforts of traditional methods and deep feature combining, loss function improving and network structure improving are involved in our analysis in the generic learning methods section. Finally, we discuss existing problems of identity information retention in virtual sample methods and domain adaption in generic learning methods. Further, we regard the semantic gap as an important future issue that needs to be considered in deep SSPP methods.

Keywords—Face Recognition; Deep Learning

I. INTRODUCTION

Face recognition is a convenient, natural and highly accurate biometric recognition technology that has always been a hot research topic in the field of pattern recognition and computer vision. In the past four decades, significant progress has been made in the face recognition field. Especially in recent years, when powerful deep learning models such as Convolutional Neural Network (CNN) has been exploited by face recognition, its accuracy can even exceed human benchmarks. The advantage of deep learning based face recognition is that the deep model can learn to extract robust features by large scale training set effectively. However, in various types of face recognition applications, such as identity card identification, passport recognition, judicial confirmation, and admission control, usually only one training sample is available for each identity. This kind of problem is called Single Sample Per Person (SSPP[1][2]) face recognition, or One Sample Per Person (OSPP), Single Image Per Person, (SIPP), one-shot face recognition. The recognition accuracy and generalization ability of either traditional method or deep learning methods will

decrease in the SSPP situation. Therefore, face recognition in the SSPP situation is still a challenging problem.

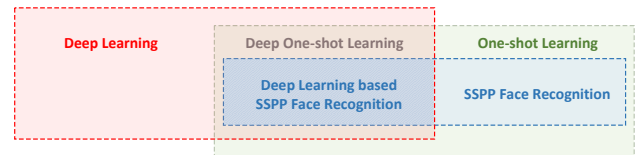

Fig. 1. Relationships between researching fields.

As shown in Fig. 1, SSPP face recognition (blue) belongs to a one-shot learning [3] problem (green). One-shot learning generally refers to the learning task with only a single labeled sample per class. It has extensive research and applications in image recognition, machine translation, and semantic analysis fields. With the rise of deep learning, one-shot learning based on deep learning has gained increasing attention. However, various deep one-shot methods cannot be directly applied to SSPP face recognition, because the inter-class difference in general one-shot task is large, whereas SSPP face recognition is a fine-grained classification task, which has smaller inter-class difference. Therefore, how to effectively apply deep learning to SSPP face recognition is still a very urgent problem.

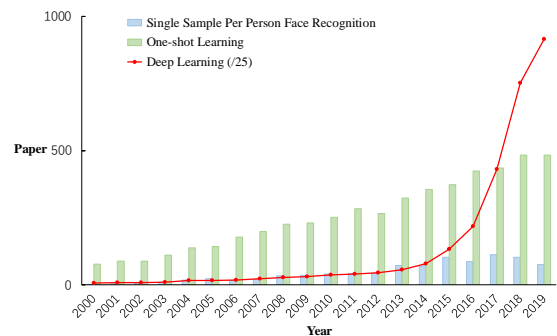

Fig. 2. Number of papers published in the past 20 years. The number of deep learning papers is large so we divided them by 25 in this figure. Data retrieved from Web of Science

In Fig. 2, we counted the number of published papers in the three fields of SSPP face recognition, one-shot learning, and deep learning in the past 20 years. Deep learning and one-shot learning have achieved a lot of results in recent years obviously, but there are not many novel methods proposed in the field of SSPP face recognition. So, it's necessary to learn from the ideas

and methods of deep learning and one-shot learning, then make specific adaptive improvements based on the characteristics of the face recognition task. This type of method is deep learning based SSPP face recognition, which is what this paper reviews. Researching in this field can not only improve the performance of face recognition model in SSPP situation, but also inspire the research in one-shot learning and deep learning at the same time.

To our best knowledge, there are two surveys for SSPP face recognition. In 2006, Tan et al. [1] classified SSPP face recognition methods into three categories: global methods, local methods, and hybrid methods. They compared and evaluated the performance of these algorithms as well. In 2019, Kumar et al. [2] summarized and reviewed the SSPP face recognition methods emerged in the last decade, they classified these methods into feature-based methods, virtual sample methods, generic learning methods, hybrid methods, and other methods. They also compared the performance of various methods and summarized the datasets for SSPP face recognition. However, the above two surveys mainly focused on traditional face recognition methods, many valuable deep learning methods for SSPP face recognition are not involved. In this paper, we focus on analyzing those deep learning based single sample per person face recognition methods. We categorize them into virtual sample methods and generic learning methods. Besides, we discuss common defects and deficiencies of existing methods. The rest of the paper is structured as follows: In section II, we review and compare deep SSPP approaches of each type in detail. Analysis and discussion are presented in section III. Finally, we summarize the contributions of this paper in section IV.

II. APPROACHES

The existing deep learning based SSPP face recognition methods can be divided into two types: virtual sample methods and generic learning methods. Applying conventional deep face recognition models to the SSPP task with the original single-sample training set often leads to model overfitting. So, a direct idea is to generate virtual samples to enlarge the training set and convert the SSPP face recognition task into a general multi-sample face recognition task. This type of method is called virtual sample methods. The other type of method is to introduce an additional multi-sample training generic set to improve the performance of the deep face recognition model. This type of method is called the generic learning method.

A. Virtual Sample Methods

The key to the virtual sample methods is to increase the intra-class variation. Before the emergence of deep learning, there have been many traditional methods to generate virtual samples, such as perturbation method [4], single image subspace method [5], random sampling method [6][7], decomposition and reconstruction method [8][9]. However, these methods are based on human-designed rules to generate virtual samples, which can only generate limited intra-class variation. To better characterize the real distribution of face samples, in recent years, researchers proposed a variety of deep learning based virtual sample methods. As shown in Fig. 3,

these methods can be divided into two categories: virtual image generation and virtual feature generation.

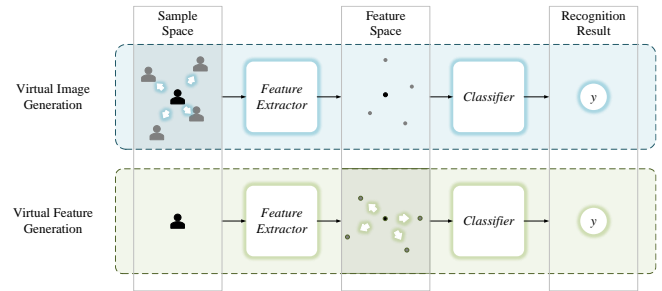

Fig. 3 Diagrams of virtual face image and feature generation methods.

1) Virtual Image Generation

Existing deep learning based virtual image generation methods are mainly based on Auto Encoders (AE) and Generative Adversarial Networks (GAN). The methods based on AE have been tried earlier and extensively. The earliest method of applying deep learning to virtual image generation is the fully connected AE based method proposed in [10] and [11]. They separate pose and identity components in latent variables in an unsupervised manner, then adjust the pose component to enable the decoder to generate virtual samples of different poses. Reed et al. [12] adopted a similarly structured Restricted Boltzmann Machine (RBM) AE, but they used a partially supervised approach to separate identity information and intra-class variation. For illumination variation, the Deep Lambertian Network (DLN) [13] proposed by Hinton et al. assumes that the face is Lambertian. Based on Deep Belief Net (DBN), they use the surface normal and the albedo to jointly represent the identity information, and use light angle vectors to represent intra-class variations.

The above three AE models use the "encode - separate and adjust latent variables - decode" generation process. Some other methods use novel network structures and different generation process. Li et al. [14] regarded the generation of virtual samples as an optimization problem, they generated the target samples by minimizing attribute loss and identity loss. Zhu et al. [15] harnessed the identity information extracted by the encoder and randomly sampled noise to jointly generate virtual samples. Zhang et al. [16] trained the AE with an auxiliary dataset, and then migrated the intra-class variation to the single sample. To ensure the generation quality and retain the identity information, the intra-class variations come from neighbor samples of the single sample, which may limit the intra-class variation generation ability.

Besides, several methods generate virtual samples with the help of GANs. Zakharov et al. [17] used the extracted face feature points to represent the intra-class variation, and the meta-learning strategy is used to make the model generate high-quality virtual samples in adversarial training. Choe et al. [18] proposed a virtual sample generation method based on Boundary Equilibrium Generative Adversarial Networks (BEGAN). This method inputs specifically adjusted latent variables into the trained BEGAN generator to obtain virtual

samples. However, the interpolation method of the mirrored faces' latent variables for pose transition may cause the identity information change in the obtained virtual sample, especially for the faces which have discriminative characteristics based on asymmetry.

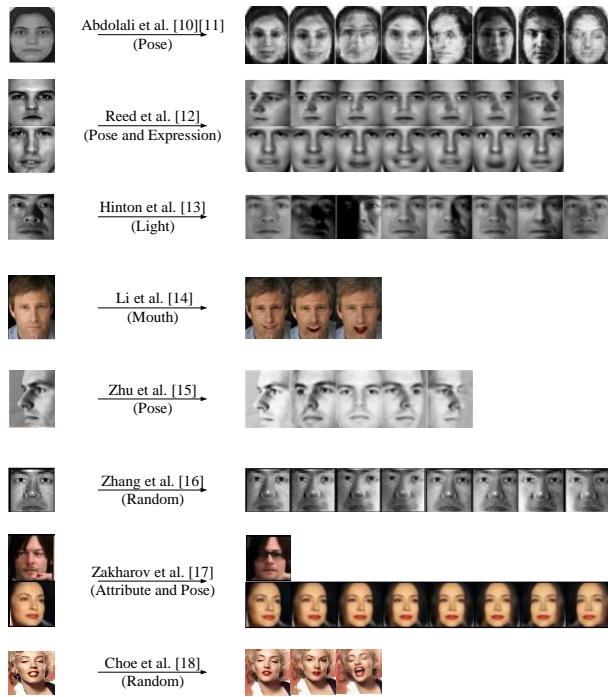

Fig. 4. Virtual images generated from corresponding input face images

Fig. 4 lists the results of virtual image generation methods based on deep learning. Due to the different training set and different input single-sample face image, it's hard to tell which method have better generation ability. Therefore, how to evaluate the quality of generated virtual samples is also an open question. Comparing recognition accuracy gain is a potential approach, but it would be greatly affected by the different structures of the face recognition model.

2) Virtual Feature Generation

In addition to the above-mentioned virtual image generation method, researchers also proposed several methods of generating virtual face features to improve the model capability in the SSPP situation. For example, Yin et al. [19] assumed that the intra-class variation of the feature vectors obeys Gaussian distributions, they generate multiple virtual features for a single sample by sampling in the corresponding distribution. Ding et al. [20] proposed a Conditional Generative Adversarial Network (CGAN) based virtual feature generation method, using adversarial training to learn the real distribution of intra-class variation, instead of simply assuming the intra-class variation obeys certain distribution. However, these two methods do not take into account the variation carried by the

single sample, they regarded the extracted single sample's feature as the center of the corresponding class in the feature space. Therefore, Ding et al. [21] proposed a dictionary-based method, selecting the intra-class variation that is most relevant to the single sample and providing them to the generator. The above methods generate virtual feature to increase the intra-class variation. Zhou et al. [22] proposed a Feature Rectification Generative Adversarial Network (FR-GAN) method to reduce the intra-class variation. They generate rectified virtual features to train the classifier.

Virtual image generation methods usually generate images with the latent variable by a decoder, the generated image will be further passed to the feature extractor and map back to the feature space. Compared to these methods, generating virtual features can avoid unnecessary information loss caused by the decoding-encoding generation process. But such methods can only help the training of the classifier in the deep model, leading to the need for separate training of the feature extractor.

B. Generic Learning Methods

The generic learning methods use an additional dataset to improve the model performance, which has been a research hotspot before the emergence of deep learning. Compared with original single-sample set based methods, generic learning methods use both original single-sample set and multi-sample generic set (a.k.a. novel set and base set).

Wang et al. [23] proposed the framework of generic learning, then Su et al. [24] and Kan et al. [25] refined the framework by Adaptive Generic Learning (AGL) and Adaptive Discriminant Analysis (ADA), respectively. Based on Equidistant Prototypes Embedding, Deng et al. proposed [26] Linear Regression Analysis (LRA) and leverage generic learning to improve the generalization performance. The sparse representation is also an important branch of generic learning. To solve the problem of performance degradation of the Sparse Representation Classifier (SRC) in the SSPP situation, Deng et al. [27] proposed an Extended SRC (ESRC) method. Liu et al. [28] [29] proposed local structure based SRC (LS_SRC) and Local Structure based Multi-phase CRC (LS_MPCRC) to solve the performance degradation of SRC and CRC in SSPP situation. With the rise of deep learning in recent years, researchers began to use deep learning to extend traditional generic learning methods. Some researchers seek to combine deep features to improve the recognition performance of traditional generic learning methods, whereas others focus on improving loss functions or network structures.

1) Traditional method and deep feature combining

To take full advantage of the good properties of sparse representations, some researchers try to combine sparse representations with features extracted by deep models. For example, Ouanan et al. [30] proposed a non-linear dictionary representation of deep feature, applied Fisher Discrimination Dictionary Learning (FDDL) [31] to deep features. Adamo et al. [32] proposed to use the k-LiMapS algorithm for SRC based face recognition, Bodini et al. [33] combined this method with deep features, and then Cuculo et al. [34] further improved the

method in face augmentation step and sparse sub-dictionary learning step. Similarly, Probabilistic Collaborative Representation based Classifier (ProCRC) [35], Semi-supervised Sparse Representation (S^3RC) [36], and Synergistic Generic Learning (SGL) [37] extended SRC from different perspectives, and they all tried to combined the proposed methods with deep features in their experiment sections. Yang et al. proposed Joint and Collaborative Representation with local Adaptive Convolution Feature (JCR-ACF) [38]. They extract deep feature from local patches, then enforce these features have similar coefficients in sparse representation. Based on JCR-ACF, the author then proposed JCR-RACF [39]. Since the local low-level features of the image share similar patterns, a shared convolutional layer is employed. Liu et al. [40] used the deep features extracted by JCR-ACF and proposed a low-rank regularized generic representation method. These traditional methods based on deep features extend the advantages of traditional methods such as sparse representation, dictionary learning, global and local methods, etc. They also take advantage of robust, representative deep features, but they have not improved the deep learning model for SSPP face recognition tasks, and have not exploited the full potential of deep learning.

2) Loss function improving

Most deep learning models learn parameters by backpropagation towards the loss function, so it is a direct idea to improve the loss function to make the model adapt to the SSPP situation. At present, the loss functions in SSPP face recognition can mainly be divided into two types: softmax loss and triplet loss.

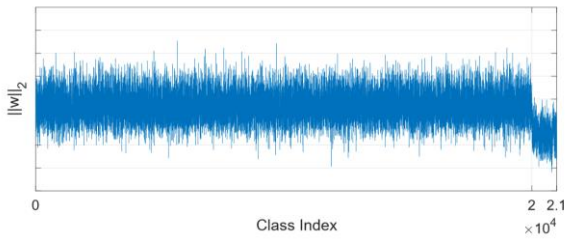

Fig. 5. Weight norms corresponding to classes in generic set and single-sample set in softmax layer. The rightmost 1000 classes correspond to the single-sample set. [48]

The training strategy of softmax loss based methods in deep SSPP methods can be divided into two types, one is to train the model by the generic set and the single-sample set separately, and the other is to train the model by a combined training set which is composed of the generic set and the single-sample set. Both two types have certain problems, and researchers proposed various solutions. In the first type, the models often fall into overfitting during fine-tuning due to the small size of the single-sample set. To this end, Zeng et al. [46] used the virtual sample method to enlarge the single-sample set when fine-tuning, Wu et al. [47] avoid fine-tuning by using a hybrid classifier composed of a softmax classifier and a nearest neighbor classifier. In the second type, generic set and the single-sample set form a combined training set. In practice, as shown in Fig. 5, researchers found that this will cause the weight norms in the Softmax layer of single-sample classes to be smaller than the

multi-sample classes, leads to classification boundary shifting and decision area decreasing. Guo et al. call those weight norms decreased class as underrepresented-classes, and proposed a novel loss term called Underrepresented-classes Promotion (UP) [48] to compensate the weight norm of the single-sample class. Wang et al. simplified the UP term, proposed to regularize weight norms instead of compensating the weight norms, further balancing the classification boundaries and reducing the computational cost in training [49]. Cheng et al. proposed an enforced softmax optimization approach, which sequentially leverage optimal dropout, selective attenuation, l_2 normalization, and model-level optimization [50]. Among them, the l_2 normalization term rectified the classification boundary by normalizing the weight norms. Those softmax loss based methods mainly focus on the weight norm decreasing problem caused by unbalance of generic set and single-sample set. In fact, this situation is an extreme case of the long-tailed distribution of the training set, so many loss functions that solve the long-tailed distribution problem can also be modified to solve the SSPP problem.

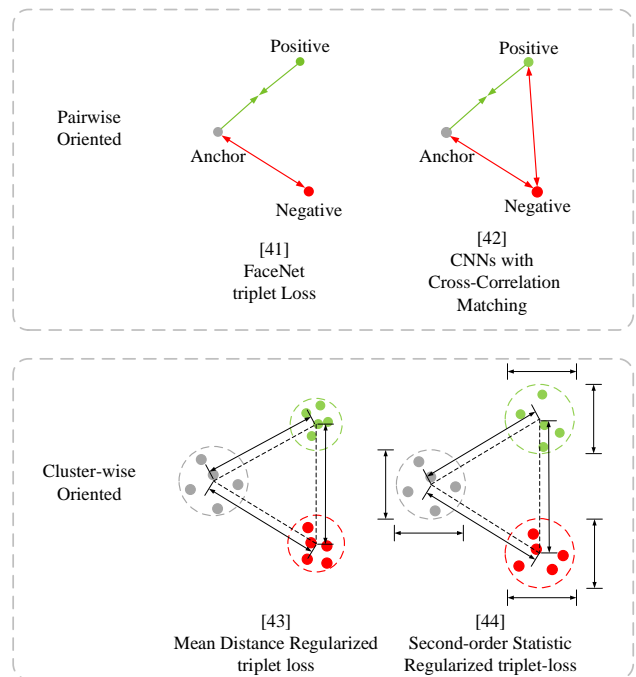

Fig. 6. pairwise oriented and cluster-wise oriented triplet loss based SSPP face recognition methods

However, some face recognition tasks could reach tens of thousands of classes, too high dimension in the softmax layer lead to great computational cost. Triplet-loss based methods can solve this problem to some extent, and have more capability on the fine-grained face recognition task. FaceNet [41] proposed to use triplet loss to reduce the distance between the anchor-positive sample pairs, and increase the distance between anchor-negative pairs. Parchami et al. [42] proposed CCM-CNN to additionally increase the distance between positive-negative pairs, further enhanced the discrimination of the extracted face features. As shown in Fig. 6, these two methods could be pairwise oriented, there are also several cluster-oriented methods. [43] proposed the Mean Distance Regularized Triplet

Loss (MDR-TL) to normalize the inter-class distance to improve the discriminatory of the model. Based on MDR-TL, [44] further normalized the intra-class distance, obtained inter-class sparse and intra-class compact face features. In the training of triplet loss based methods, better triplet selection can promote convergence, also enhance the robustness of the feature extractor. Therefore, [45] proposed a Doppelganger Mining (DM) method, which uses softmax loss to maintain a list with the most similar identities for each identity in the training set, thereby generating better mini-batches then benefiting the training of deep model.

3) Network structures improving

Based on the conventional deep learning model, loss function improvement can effectively overcome difficulties of the SSPP situation. At the same time, a novel network structure can also benefit the model. For example, to obtain Face Identity-Preserving (FIP) [51] features, Zhu et al. added a normalized face reconstruction task after extracting features from CNN, as shown in Fig. 7. However, the model may use only certain parts of the dimensions in the FIP feature for reconstruction, while the other dimensions are still affected by intra-class variation. Gao et al. proposed a Stacked Supervised Auto-Encoders (SSAE) [52]. The model reconstructs normalized face similar to [51]. They additionally enforce the features extracted from the normalized face and varied face to be similar, thus minimizing the impact of intra-class variation. Since AE with sparsity constrain can usually achieve better performance, SSAE uses a sparse regularization loss term based on KL divergence.[53] experimentally tested three forms of sparse regularization terms and found that regularization term based on KL divergence achieves the best performance. [54] Trains SSAE using face samples automatically extracted from video data. Compared with the hand-made dataset in [52], the distribution of intra-class variation of face samples in the video is closer to the distribution of real data, so better results are obtained. Based on the network structure of the FIP method, Deng et al. added another reconstruction task that reconstructs the original input face from normalized face [55]. Such a network structure helps the model

to effectively separate identity information and intra-class variation, thereby improve the feature robustness.

The above methods obtain robust features by adding auxiliary reconstruction task, reducing the impact of intra-class variation on features. In addition, some researchers point out that deep learning models can also use optimization methods other than backpropagation to learn parameters, which can also help the model to face the SSPP situation. Chan et al. proposed to use PCA to learn convolution kernel parameters [56], then [57] added a weighted voting scheme based on local patch, further improved the model performance. Based on sparse representation, Zhang et al. designed an end-to-end deep cascade model without backpropagation for SSPP face recognition tasks [58]. [59] proposed a SSPP face recognition model based on a sparse autoencoder. They use a fuzzy rough set theory to obtain redundant removed parameters. These deep methods alleviate the problem of overfitting caused by the SSPP situation to some extent. At the same time, novel parameter learning schemes can not only ensure that the model effectively extracts features from the single sample, but also reduce the computational cost in training.

In generic learning methods, the deep model learns the representation and discrimination of face samples on the generic set which is the source domain, and applies it to the single sample set which is the target domain. Models could suffer from two drawbacks because of the difference between the source and target domains. The first is over-adaptation, that is, the deep model overfits the target domain and forgets the knowledge learned from the source domain; the other is under-adaptation, which means that the model fails to make good use of the information in the target domain and cannot adapt to it. For the first type of problem, [60] proposed a transfer learning method based on Restricted Parameter Learning (RPL). The RPL limits the learning of the CNN parameters during training and truncate gradients with a threshold. For the second type of problem, the SSPP-DAN [61] applied Domain Adaptation Network (DAN) to SSPP face recognition task, using domain discriminator to enforce the feature extractor to generate domain robust feature.

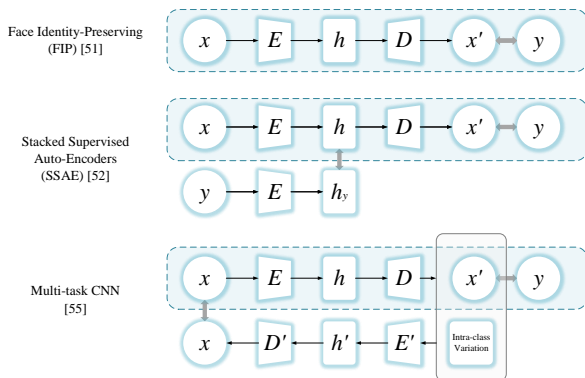

Fig. 7. Network structure improving based on FIP method [51]. x denotes face image carried certain variation, x' and y are normalized face.

III. ANALYSIS AND DISCUSSION

Reviewing existing SSPP face recognition methods, we found the following problems.

A. Identity Information Retention of Virtual Sample Methods

In current deep virtual sample methods, AE and GAN are the common choices. The structure of AE expects that the model can retain as much information as possible through the reconstruction process. This is conducive to the retention of identity information but limits the learning and generation of intra-class so that generated faces are prone to possess similar features. GAN can fulfill stronger intra-class variation generation. However, the two-player min-max training makes the model difficult to converge. Thus, it is necessary to study how to better use the advantages of both AE and GAN to increase the intra-class variation of the single sample while retaining its identity information.

B. Domain Adaptation in Generic Learning

Domain adaptation is a branch of transfer learning, it's a learning technique to address the problem of lacking massive amounts of high-quality, large-scale labeled data [62]. Therefore, with the continuous development of deep learning, designing deep networks for domain adaptation is a new research direction. The domain adaption methods used for face recognition tasks are generally to resolve the difference between the training set and the test set. However, in many generic learning based SSPP face recognition tasks, there are also differences between the generic set and the single-sample set. However, there are still few methods for this problem, which needs further study. In addition, due to the imbalance between the generic set and single-sample set, it is easy to cause negative adaption to the single-sample target domain. Therefore, how to ensure the robustness of domain adaptation is also an urgent problem.

C. Semantic Gap

Although the virtual samples or generic sets can characterize the intra-class variation and improve the recognition performance to some extent, it cannot fundamentally solve the semantic gap problem in the SSPP situation. When learning face recognition, current deep models usually rely on large-scale labeled training set, but the human brain seems to work differently: we are used to using semantic transfer modes. There is a hierarchical relationship between different semantics. Low level semantics are combined to form a high level semantics, high level of semantics can be combined to form a higher level semantics. However, current deep SSPP face recognition models lack explicit semantic transfer in the learning process.

In some harsh environments, many of the best visual systems still cannot compete with human visual systems. Therefore, researchers paid more and more attention to learn from physiology and cognitive science, and proposed a variety of models based on the theory of visual perception. The current deep learning method is also developed from simulating the connection mechanism of human brain neurons. However, most of the current deep SSPP face recognition methods have not considered the semantic information such as gender, age, ethnicity and the semantics implied in the face image, which leads to the lack of image recognition capabilities with semantic understanding. Therefore, learning from the semantic understanding mechanism of the human visual perception system, and developing deep learning methods from the perspective of semantics to solve the challenge of SSPP face recognition is an area worthy of in-depth study. It is also a deeper understand and exploration of human visual perception.

IV. CONCLUSION

This paper presented a comprehensive survey on deep learning based single sample per person face recognition. Existing methods are classified into virtual sample methods and generic learning methods. Virtual sample methods generate virtual face image or virtual face features for data argument, they are straightforward and intuitive for building the training pipeline. Identity-preserving is important for this type of method because the variation of identity information will harm the training of the follow-up face recognition model. Generic learning uses an additional dataset to improve the deep model.

Researchers improve the generic learning model from different perspectives, including combining deep features with traditional methods, as well as loss function and network structure improving. Lots of efforts have been done in recent years, but we point out that the domain adaption problem worth further research. From a higher level of view, problems encountered in different types of deep SSPP methods can be attributed to the semantic gap. How to design a deep model to meet the challenge of SSPP face recognition from the perspective of the semantic gap is worth in-depth research.

REFERENCES

- [1] Tan X, Chen S, Zhou Z H, et al. Face recognition from a single image per person: A survey[J]. *Pattern recognition*, 2006, 39(9): 1725-1745.
- [2] Kumar N, Garg V. Single sample face recognition in the last decade: A survey[J]. *International Journal of Pattern Recognition and Artificial Intelligence*, 2019, 33(13): 1956009.
- [3] Feifei L, Fergus R, Perona P. One-shot learning of object categories[J]. *IEEE Transactions on Pattern Analysis and Machine Intelligence*, 2006, 28(4):594-611.
- [4] Martínez A M. Recognizing imprecisely localized, partially occluded, and expression variant faces from a single sample per class[J]. *IEEE Transactions on Pattern Analysis and Machine Intelligence*, 2002, 24(6): 748-763.
- [5] Liu J, Chen S, Zhou Z H, et al. Single image subspace for face recognition[C] //Proceedings of the 3rd International Workshop on Analysis and Modeling of Faces and Gestures (AMFG). Rio de Janeiro, Brazil: Springer Verlag, 2007: 205-219.
- [6] Li J B, Pan J S, Chu S C. Face recognition from a single image per person using common subspaces method[C] //International Symposium on Neural Networks. Nanjing, China: Springer, 2007: 905-912.
- [7] Vasilescu M A O, Terzopoulos D. Multilinear subspace analysis of image ensembles[C] //Proceedings of the 2003 IEEE Computer Society Conference on Computer Vision and Pattern Recognition (CVPR). Madison, WI, USA: IEEE, 2003: II-93.
- [8] Li X, Song A. Face recognition using m-MSD and SVD with single training image[C] //Proceedings of the 30th IEEE Chinese Control Conference. Yantai, China: IEEE, 2011: 3231-3233.
- [9] Majumdar A, Ward R K. Single image per person face recognition with images synthesized by non-linear approximation[C] //Proceedings of the 2008 15th IEEE International Conference on Image Processing. San Diego, CA, USA: IEEE, 2008: 2740-2743.
- [10] Abdolali F, Seyyedsalehi S A. Face recognition from a single image per person using deep architecture neural networks[C] // Proceedings of the 3rd International Conference on Computer and Electrical Engineering (ICCEE). Chengdu, China: IEEE, 2010: 1: 70-73.
- [11] Abdolali F, Seyyedsalehi S A. Improving face recognition from a single image per person via virtual images produced by a bidirectional network[J]. *Procedia-Social and Behavioral Sciences*, 2012, 32: 108-116.
- [12] Reed S, Sohn K, Zhang Y, et al. Learning to disentangle factors of variation with manifold interaction[C] //Proceedings of the 31st International Conference on Machine Learning (ICML). Beijing, China: IMLS, 2014: 1431-1439.
- [13] Tang Y, Salakhutdinov R, Hinton G. Deep lambertian networks[J]. *ArXiv Preprint*, ArXiv:1206.6445, 2012.
- [14] Li M, Zuo W, Zhang D. Convolutional network for attribute-driven and identity-preserving human face generation[J]. *ArXiv Preprint*, ArXiv:1608.06434, 2016.
- [15] Zhu Z, Luo P, Wang X, et al. Multi-view perceptron: A deep model for learning face identity and view representations[C] //Proceedings of the 2014 International Conference on Neural Information Processing Systems (NIPS). Kuching, Malaysia: MIT Press, 2014: 217-225.
- [16] Zhang Y, Peng H. Sample reconstruction with deep autoencoder for one sample per person face recognition[J]. *IET Computer Vision*, 2017, 11(6): 471-478.

- [17] Zakharov E, Shysheya A, Burkov E, et al. Few-shot adversarial learning of realistic neural talking head models[C] //Proceedings of the 2019 IEEE International Conference on Computer Vision (ICCV). Seoul, Korea: IEEE, 2019: 9459-9468
- [18] Choe J, Park S, Kim K, et al. Face generation for low-shot learning using generative adversarial networks[C] //Proceedings of the 2017 IEEE International Conference on Computer Vision Workshops (ICCVW). Venice, Italy: IEEE, 2017: 1940-1948.
- [19] Yin X, Yu X, Sohn K, et al. Feature transfer learning for face recognition with under-represented data[C] //Proceedings of the 2019 IEEE International Conference on Computer Vision (ICCV). Seoul, Korea: IEEE, 2019: 5704-5713.
- [20] Ding Z, Guo Y, Zhang L, et al. One-shot face recognition via generative learning[C] //Proceedings of the 2018 13th IEEE International Conference on Automatic Face & Gesture Recognition (FG). Xi'an, China: IEEE, 2018: 1-7.
- [21] Ding Z, Guo Y, Zhang L, et al. Generative one-shot face recognition[J]. ArXiv Preprint, ArXiv:1910.04860, 2019.
- [22] Zhou J, Chen J, Liang C, et al. One-shot face recognition with feature rectification via adversarial learning[C] //Proceedings of the 2020 International Conference on Multimedia Modeling (MMM). Daejeon, Korea: Springer, 2020: 290-302.
- [23] Wang J, Plataniotis K N, Lu J, et al. On solving the face recognition problem with one training sample per subject[J]. Pattern Recognition, 2006, 39(9): 1746-1762.
- [24] Su Y, Shan S, Chen X, et al. Adaptive generic learning for face recognition from a single sample per person[C] //Proceedings of the 2010 IEEE Computer Society Conference on Computer Vision and Pattern Recognition (CVPR). San Francisco, CA, USA: IEEE, 2010: 2699-2706.
- [25] Kan M, Shan S, Su Y, et al. Adaptive discriminant learning for face recognition[J]. Pattern Recognition, 2013, 46(9): 2497-2509.
- [26] Deng W, Hu J, Zhou X, et al. Equidistant prototypes embedding for single sample based face recognition with generic learning and incremental learning[J]. Pattern Recognition, 2014, 47(12): 3738-3749.
- [27] Deng W, Hu J, Guo J. Extended SRC: Under sampled face recognition via intra-class variant dictionary[J]. IEEE Transactions on Pattern Analysis and Machine Intelligence, 2012, 34(9): 1864-1870.
- [28] Liu F, Tang J, Song Y, et al. Local structure-based sparse representation for face recognition[J]. ACM Transactions on Intelligent Systems and Technology, 2015, 7(1): 1-20.
- [29] Liu F, Tang J, Song Y, et al. Local structure based multi-phase collaborative representation for face recognition with single sample per person[J]. Information Sciences, 2016, 346-347:198-215.
- [30] Ouanan H, Ouanan M, Aksasse B. Non-linear dictionary representation of deep features for face recognition from a single sample per person[J]. Procedia Computer Science, 2018, 127: 114-122.
- [31] Yang M, Zhang L, Feng X, et al. Fisher discrimination dictionary learning for sparse representation[C] //Proceedings of the 2011 International Conference on Computer Vision (ICCV). Barcelona, Spain: IEEE, 2011: 543-550.
- [32] Adamo A, Grossi G, Lanzarotti R. Sparse representation based classification for face recognition by k-LiMapS algorithm[C] //Proceedings of the International Conference on Image and Signal Processing. Agadir, Morocco: Springer, 2012: 245-252.
- [33] Bodini M, D'Amelio A, Grossi G, Lanzarotti R, Lin J. Single sample face recognition by sparse recovery of deep-learned LDA features[C] //Proceedings of the 2018 International Conference on Advanced Concepts for Intelligent Vision Systems. Poitiers, France: Springer, 2018:297-308.
- [34] Cuculo V, D'Amelio A, Grossi G, et al. Robust single-sample face recognition by sparsity-driven sub-dictionary learning using deep features[J]. Sensors, 2019, 19(1): 146.
- [35] Cai S, Zhang L, Zuo W, and Feng X, A probabilistic collaborative representation based approach for pattern classification[C] //Proceedings of the 2012 IEEE Computer Society Conference on Computer Vision and Pattern Recognition (CVPR). Washington, USA: IEEE, 2012: 2950-2959.
- [36] Gao Y, Ma J, and Yuille A L. Semi-supervised sparse representation based classification for face recognition with insufficient labeled samples[J]. IEEE Transactions on Image Processing, 2017, 26(5): 2545-2560.
- [37] Pang M, Cheung Y M, Wang B, et al. Synergistic generic learning for face recognition from a contaminated single sample per person[J]. IEEE Transactions on Information Forensics and Security, 2019, 15: 195-209.
- [38] Yang M, Wang X, Zeng G, et al. Joint and collaborative representation with local adaptive convolution feature for face recognition with single sample per person[J]. Pattern Recognition, 2017, 66: 117-128.
- [39] Wen W, Wang X, Shen L, et al. Adaptive convolution local and global learning for class-level joint representation of face recognition with single sample per person[C] //Proceedings of the 2018 IEEE International Conference on Pattern Recognition (ICPR). Beijing, China: IEEE, 2018: 3537-3542.
- [40] Liu F, Ding Y, Xu F, et al. Learning low-rank regularized generic representation with block-sparse structure for single sample face recognition[J]. IEEE Access, 2019, 7: 30573-30587.
- [41] Schroff F, Kalenichenko D, Philbin J. FaceNet: A unified embedding for face recognition and clustering[C] //Proceedings of the 2015 IEEE conference on computer vision and pattern recognition (CVPR). Boston, Massachusetts, USA: IEEE, 2015: 815-823.
- [42] Parchami M, Bashbaghi S, Granger E. CNNs with cross-correlation matching for face recognition in video surveillance using a single training sample per person[C] //Proceedings of the 14th IEEE International Conference on Advanced Video and Signal Based Surveillance (AVSS). Lecce, Italy: IEEE, 2016: 1-6.
- [43] Ding C, Tao D. Trunk-branch ensemble convolutional neural networks for video-based face recognition[J]. IEEE Transactions on Pattern Analysis and Machine Intelligence, 2017, 40(4):1002-1014.
- [44] Parchami M, Bashbaghi S, Granger E. Video-based face recognition using ensemble of haar-like deep convolutional neural networks[C] //Proceedings of the International Joint Conference on Neural Networks. Alaska, USA : IEEE, 2017: 4625-4632.
- [45] Smirnov E, Melnikov A, Novoselov S, et al. Doppelganger mining for face representation learning[C] //Proceedings of the 2017 IEEE International Conference on Computer Vision Workshops. Venice, Italy: IEEE, 2017: 1916-1923.
- [46] Zeng J, Zhao X, Qin C, et al. Single sample per person face recognition based on deep convolutional neural network[C] //Proceedings of the 3rd IEEE International Conference on Computer and Communications (ICCC). Chengdu, China: IEEE, 2017: 1647-1651.
- [47] Wu Y, Liu H, Fu Y. Low-shot face recognition with hybrid classifiers[C] //Proceedings of the 2017 IEEE International Conference on Computer Vision Workshops. Venice, Italy: IEEE, 2017: 1933-1939.
- [48] Guo Y, Zhang L. One-shot face recognition by promoting underrepresented classes[J]. ArXiv Preprint, ArXiv:1707.05574, 2017.
- [49] Wang L, Li Y, Wang S. Feature learning for one-shot face recognition[C] //Proceedings of the 2018 25th IEEE International Conference on Image Processing (ICIP). Athens, Greece: IEEE, 2018: 2386-2390.
- [50] Cheng Y, Zhao J, Wang Z, et al. Know you at one glance: A compact vector representation for low-shot learning[C] //Proceedings of the 2017 IEEE International Conference on Computer Vision Workshops (ICCVW). Venice, Italy: IEEE, 2017: 1924-1932.
- [51] Zhu Z, Luo P, Wang X, et al. Deep learning identity-preserving face space[C] //Proceedings of the 2013 IEEE International Conference on Computer Vision (ICCV). Sydney, Australia: IEEE, 2013: 113-120.
- [52] Gao S, Zhang Y, Jia K, et al. Single sample face recognition via learning deep supervised autoencoders[J]. IEEE Transactions on Information Forensics and Security, 2015, 10(10): 2108-2118.
- [53] Viktorisa O Y, Wasito I, Syafiandini A F. Evaluating the performance of deep supervised auto encoder in single sample face recognition problem using Kullback-Leibler divergence sparsity regularizer[J] //Journal of Theoretical and Applied Information Technology, 2016, 87(2): 255-258.
- [54] Vega P J S, Feitosa R Q, Quirita V H A, et al. Single sample face recognition from video via stacked supervised auto-encoder[C] //Proceedings of the 29th SIBGRAPI Conference on Graphics, Patterns and Images (SIBGRAPI). Sao Paulo, Brazil: IEEE, 2016: 96-103.
- [55] Wu Z, Deng W. One-shot deep neural network for pose and illumination normalization face recognition[C] //Proceedings of the 2016 IEEE

- International Conference on Multimedia and Expo (ICME). Seattle, WA, USA:IEEE, 2016: 1-6.
- [56] Chan T H, Jia K, Gao S, et al. PCANet: A simple deep learning baseline for image classification?[J]. IEEE transactions on Image Processing, 2015, 24(12): 5017-5032.
- [57] Ding C, Bao T, Karmoshi S, et al. Single sample per person face recognition with KPCANet and a weighted voting scheme[J]. Signal, Image and Video Processing, 2017, 11(7):1213–1220.
- [58] Zhang L, Liu J, Zhang B, et al. Deep cascade model-based face recognition: When deep-layered learning meets small data[J]. IEEE Transactions on Image Processing, 2019, 29: 1016-1029.
- [59] Guo Y, Jiao L, Wang S, et al. Fuzzy sparse autoencoder framework for single image per person face recognition[J]. IEEE Transactions on Cybernetics, 2018, 48(8): 2402-2415.
- [60] You F, Cao Y, Zhang C. Deep domain adaptation with a few samples for face identification[C]//Proceedings of the 4th IAPR Asian Conference on Pattern Recognition (ACPR). Nanjing, China: IEEE, 2017: 178-183.
- [61] Hong S, Im W, Ryu J, et al. SSPP-DAN: Deep domain adaptation network for face recognition with single sample per person[C]//Proceedings of the 2017 IEEE International Conference on Image Processing (ICIP). Beijing, China: IEEE, 2017: 825-829.
- [62] Wang M, Deng W. Deep visual domain adaptation: A survey[J]. Neurocomputing, 2018, 312: 135-153.