



Queensland University of Technology
Brisbane Australia

This may be the author's version of a work that was submitted/accepted for publication in the following source:

Dinh, Tuan Le, Hu, Wen, Sikka, Pavan, [Corke, Peter](#), Overs, Leslie, & Brosnan, Stephen
(2007)

Design and deployment of a remote robust sensor network: Experiences from an outdoor water quality monitoring network.

In Frank, M & Elmallah, E (Eds.) *Proceedings of the 2nd IEEE International Workshop on Practical Issues In Building Sensor Network Applications (SenseApp 2007) incorporated with the 32nd IEEE Conference on Local Computer Networks (LCN 2007)*.

Institute of Electrical and Electronics Engineers Inc., United States of America, pp. 799-806.

This file was downloaded from: <https://eprints.qut.edu.au/33774/>

© Copyright IEEE 2007

Personal use of this material is permitted. However, permission to reprint/republish this material for advertising or promotional purposes or for creating new collective works for resale or redistribution to servers or lists, or to reuse any copyrighted component of this work in other works must be obtained from the IEEE.

Notice: *Please note that this document may not be the Version of Record (i.e. published version) of the work. Author manuscript versions (as Submitted for peer review or as Accepted for publication after peer review) can be identified by an absence of publisher branding and/or typeset appearance. If there is any doubt, please refer to the published source.*

<https://doi.org/10.1109/LCN.2007.39>

Design and Deployment of a Remote Robust Sensor Network: Experiences from an Outdoor Water Quality Monitoring Network

Tuan Le Dinh*[†] Wen Hu* Pavan Sikka* Peter Corke* Leslie Overs* Stephen Brosnan*

*Autonomous Systems Laboratory, CSIRO ICT Centre, Brisbane, Australia

{tuan.ledinh, wen.hu, pavan.sikka, peter.corke, leslie.overs, stephen.brosnan}@csiro.au

[†]School of Computer Science and Engineering, UNSW, Australia

Abstract—This paper investigates a wireless sensor network deployment — monitoring water quality, e.g. salinity and the level of the underground water table — in a remote tropical area of northern Australia. Our goal is to collect real time water quality measurements together with the amount of water being pumped out in the area, and investigate the impacts of current irrigation practice on the environments, in particular underground water salination.

This is a challenging task featuring wide geographic area coverage (mean transmission range between nodes is more than 800 meters), highly variable radio propagations, high end-to-end packet delivery rate requirements, and hostile deployment environments. We have designed, implemented and deployed a sensor network system, which has been collecting water quality and flow measurements, e.g., water flow rate and water flow ticks for over one month. The preliminary results show that sensor networks are a promising solution to deploying a sustainable irrigation system, e.g., maximizing the amount of water pumped out from an area with minimum impact on water quality.

I. INTRODUCTION

This paper explores the use of wireless sensor network technology to study the impacts of current irrigation practice on the environment in the Burdekin area, Queensland, Australia (see Fig. 1).

Saltwater intrusion into coastal aquifers due to poor management is an ongoing concern for water managers globally. The principal decisions to be made in relation to exploiting these coastal groundwater resources are: where to place the extraction bores, and how much water can be extracted sustainably. Once a coastal aquifer has become infiltrated with saline water, it is difficult and expensive to remedy.

Steadily rising salinity levels have been noticed in a number of production bores near the coast in the Lower Burdekin region (see Fig. 1). There is concern that the ground water resource in these areas may be degrading, but the extent and the cause of the problem are not well understood. Consequently, the management options available and the efficacy of particular options are also not well understood.

The Airdmillan Road area (approximately 2km × 3km, see the area inside yellow line in Fig. 1), which is centrally located within the Burdekin irrigation area, is an area of particular concern. One recommendation of a previous study was that all the extraction bores in the Airdmillan Road area be metered (including date stamping), as it is unclear how much water is

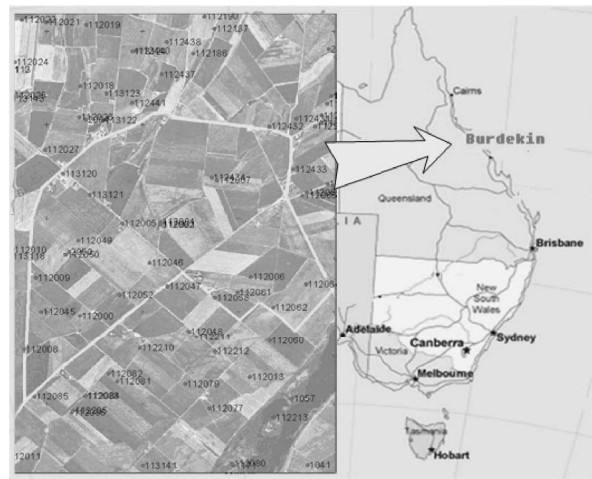

Fig. 1. Airdmillan Road area (around 2km × 3km, inside the yellow line) is an area of concern in the lower region Burdekin, a remote coastal area in Queensland, Australia.

being extracted from the aquifer, and it is suspected that there may be some interplay between aquifer stress and the timing of the extraction.

Our goal is to deploy a wireless sensor network which can operate unattended, is capable of monitoring the amount of water being pumped out from the area, and can measure the impacts of water extraction on water quality, e.g., water salinity and underground water table level, and to eventually design a sustainable water irrigation system. It is challenging to implement and deploy such a sensor network for a *real world industrial application*. Our work builds on lessons in robust, adaptive system design from current sensor deployments for habitat monitoring [2]–[4], [14].

The purpose of this paper is to explain this system contribution as a mote, robust industrial sensor networks.

- We describe the use of a wireless sensor network for the real world industrial sensing application (water quality monitoring). This application involves unattended operations, high data packet delivery rate in a highly unstable radio environment. We designed, implemented, and deployed a robust sensor network system that has been

TABLE I
SENSOR RESOLUTION REQUIREMENTS.

Sensors	Min	Max	Resolution
Salinity ($\mu S/cm$)	0	100,000	10
Water level (cm)	0	3,000	5
Flow rate ($liter/s$)	0	100	0.5
Flow volume ($tick/s$)	0	200	1

working in the field over one month. Preliminary results show that our sensor network system is a promising solution to a sustainable irrigation system.

- To help our system survive the hostile tropical environment, we have designed a custom water-roof housing. To increase the robustness of the system, we have implemented watchdog logics at both the remote gateway and sensor nodes.
- To form a fully connected wireless network, we have chosen radio with transmission range up to 1,500 meters, for our system. We have also discovered the unique challenges of deploying a sparse fully connected sensor system in an outdoor tropical environment. These challenges contradict some common assumptions in both theory and simulation research, and require further effort from the sensor network research community.

In the rest of the paper, we provide an overview of water quality sensor network requirements (Section II) which drives our system design, describe the architecture and components our systems (Section III), discuss the sensor network deployment lessons and preliminary results in (Section IV), and discuss related work in sensor network applications and deployments (Section V). Section VI describes future research directions, and our conclusions.

II. SYSTEM REQUIREMENTS

In this section, we describe the application requirements of our water quality monitoring sensor network.

- **Sensor (Calibration/Resolution/Sample rate) Requirements:** Our system consists of four types of sensors, e.g., salinity, water level, water flow, and water volume at each irrigation bore. As shown in Table I, the water volume sensor provides digital inputs/pulses to the node. Each tick/pulse represents 1 liter water passing through the irrigation pipe. The others are analog sensors. The salinity sensor must be able to measure up to 100,000 $\mu S/cm$ salinity level in the water, and provide a measurement resolution of 10 $\mu S/cm$. The water level sensor must be able to measure up to 30 meters water depth variance, and provide a measurement resolution of 5 cm. The flow rate sensor must be able to measure up to 100 liter/s flow rate, and provide a measurement resolution of 0.5 liter/s (see Table I. The sample rate of analog sensors is a sample per minute. The sensors must be robust enough to operate in a harsh tropical environment with high humidity, high temperature, iron deposit, and acid cleaning liquid. Further, the sizes of observation bores, where we deploy the pressure sensor to measure the level

of water table are around 75 mm, which limits the size of the water level pressure sensor.

- **System Maintenance/Service:** Because the sensor system will be operating in a remote area, which is about 2,000 km from our lab, and our local partners have limited knowledge of embedded systems, the sensor system must be capable of operating independently for long periods of time, i.e. weeks or even months. This means that our system must be robust to environment dynamics, software failures, power supply outages, etc.
- **Sensor Platform and Package:** Because the sensor network is sparse (5 nodes in an area of about 2km \times 3km (see Fig. 1)), the radio range of the nodes must be long, i.e. more than 1km. Further, we need to deploy extra networking nodes to improve network connectivity. In order to make the system work in this environment, the sensor housings must be waterproof and be able to survive high humidity.
- **Network Delivery Rate:** In the future, irrigators may be charged rates based on the amount of water they use. Therefore, the flow readings have to be delivered reliably (more than 75% end-to-end packet delivery rate). This desired reliability comes from domain experts at CSIRO land and water division [1].

In next section, we will introduce the architecture of our sensor system, which is tailored to meet these challenging requirements.

III. SYSTEM ARCHITECTURE

We describe both hardware and software architecture of our sensor system in this section.

A. Hardware Components

The sensor nodes in the Burdekin deployment are based on Fleck3 platform [18]. Like its predecessor (the fleck1c), the Fleck3 is built around the Atmel Atmega128 micro-controller, with 4 kBytes of RAM and an 8 MHz CPU. Unlike the Fleck1c, the Fleck3 uses the packet-based Nordic NRF905 transceiver for communication. In particular, the NRF905 radio has a longer transmission range, up to 1,500 meters versus 700 meters for the NRF903 used in the Fleck1c. This is critical for a sparse sensor network deployed in a large area such as Burdekin. The Fleck3 also features 1 MByte of flash storage and a real-time clock.

The hardware architecture relies heavily on the SPI bus. The Atmega128 acts as the SPI master and can communicate with the radio, the flash memory, the real-time clock, and the temperature sensor over the SPI interface. The real-time clock and the radio can both interrupt the Atmega128 to signal alarms, packet transmission, and packet reception.

The sensor pack for the Burdekin deployment is based on commercially available sensors. The sensors provide 4-20 mA outputs and are interfaced to the Fleck3 through an adapter board which provides a 16-bit ADC connected to the micro-controller by the SPI bus.

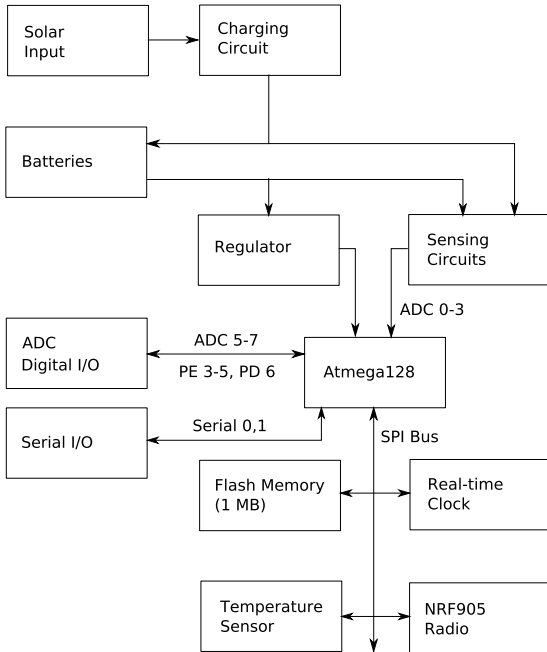

Fig. 2. The Fleck3 node architecture.

Fig. 4 shows the sensors being used in the deployment. Electrical Conductivity (a measure for salinity) is provided by a Toroidal Conductivity Sensor TCS1000 made by Senorex. The depth of the water table is measured by a PS100 pressure sensor made by Tyco. The electro-magnetic flow meters are made by Krohne and provide both flow volume and flow rate. The flow volume is provided as digital pulses and is connected to the micro-controller using a digital I/O pin. Fig. 3 shows the sensor node deployed at one of the pump sites. The flow meter and the EC sensor are mounted in the pipe connecting the pump to the reservoir tank. The pressure sensor is mounted in an observation bore next to the pump. The sensor network gateway has been designed for long-term, remote, and unattended operation. It is based on an ARM-based board from Technologic Systems, and runs Linux. The board is connected to a fleck3 via the serial port and runs a serial forwarder. The gateway computer connects to the Internet using an ADSL modem. The computer can be reset by a hardware watchdog. It also monitors the network traffic, and has the ability to switch the ADSL modem on and off using a digital I/O line.

B. Communication Software Components

We used TinyOS [5] as the operating system for the Fleck3. Taking into account the system requirements introduced in Section II, we employ reliable protocols in each communication layer (see Fig. 5).

We chose a state-of-the-art sensor network routing protocol in the network layer [24]. Surge_Reliable is a reliable multi-hop routing protocol that uses link quality as its routing metric. Surge dynamically forms a reliable spanning tree that covers every node in the network, using link connectivity

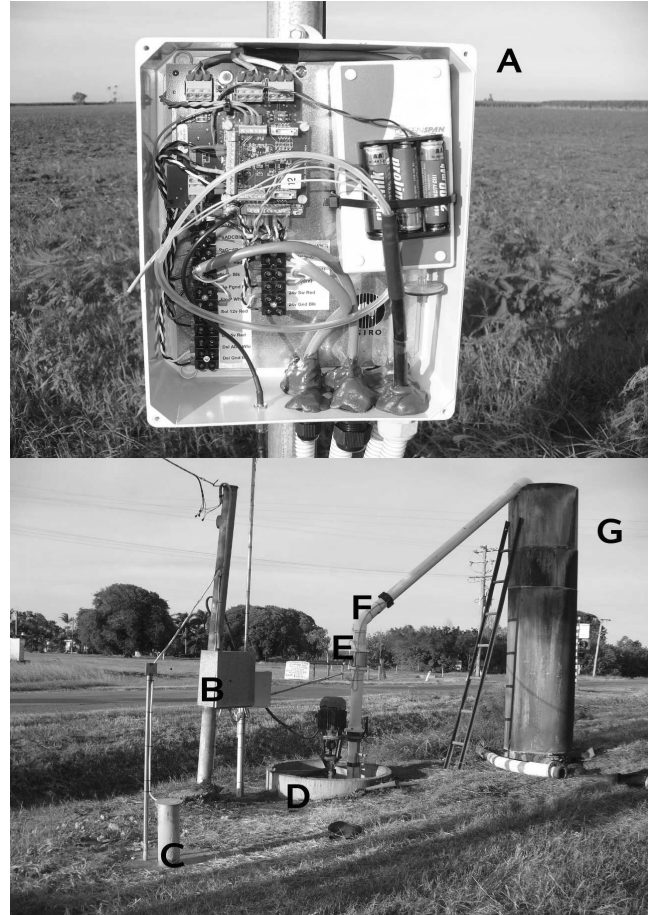

Fig. 3. The sensor node deployed at one of the pump sites in the Burdekin. (A) Sensor node details. (B) Sensor node housing. (C) Bore containing water level sensor. (D) Pump. (E) Flow meter. (F) EC sensor. (G) Tank.

estimation and neighborhood table management techniques. In surge protocol, each node periodically measures the link qualities between itself and its neighbours, and selects “the best” neighbour as its parent to forward data to the base station. The performance of Surge_Reliable has been shown to be superior to other routing protocols including shortest-path, DSDV, AODV, in unreliable wireless environments.

Because of the limited energy budget, sensor network nodes generally use low TX power. Consequently, the wireless links in sensor networks are typically unreliable, i.e. have high packet loss rates. Previous work [24] shows that hop-to-hop packet recovery can increase end-to-end delivery rate significantly in sensor networks. We have implemented a CSMA style Medium Access Control (MAC) that features acknowledgement using the NRF905 radio. The MAC layer timeout is set to 10 milliseconds, and the number of MAC layer transmission retries is 6.

An end-to-end Negative Acknowledgement (NACK) with aggregated positive Acknowledgement (ACK) mechanisms are used in the transport layer. The base station receives packets

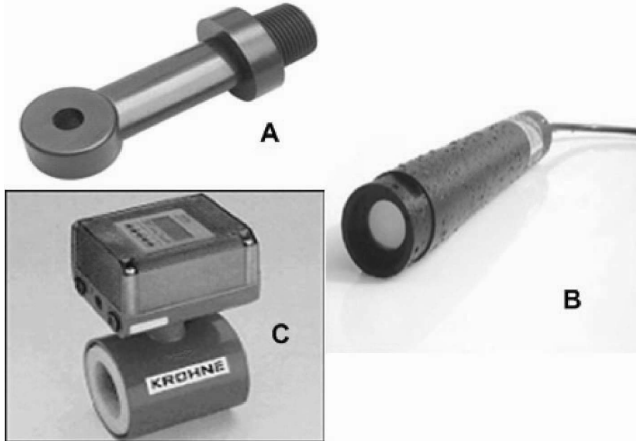

Fig. 4. The pictures of water quality sensors. A. Sensorex TCS1000 salinity sensor; B. Tyco PS100 pressure (water level) sensors; C. Krohne electromagnetic flow meter sensor.

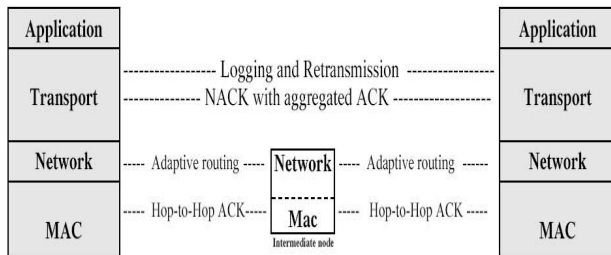

Fig. 5. The architecture of reliable network protocols.

from different sources (nodes), and sends NACK if and only if missing packets are found. By inspecting the sequence numbers on the packets, the base station can detect which packets were lost. The source assumes that the packet has been delivered successfully to the sink if it does not receive any NACKs within a timeout period. The sources store copies of packets in their buffers before sending them out.

IV. DEPLOYMENT, RESULTS AND DISCUSSIONS

In this section, we discuss experiences, preliminary results, and lessons learned from the Burdekin water quality sensor network deployment.

A. System Deployment

At the end of Feb 2007, we deployed the sensor system with eight nodes (see Fig. 6) during the dry season in the Southern hemisphere when salinity levels in the water become interesting. Our original plan was to link the sensor network directly to the office located about 4 km from the study area using several relay nodes with high-gain antennas. However, a site-survey in December 2006 identified a water tower located in the path loaded with GSM antennas that made it

impossible to achieve this (radio interference). Our interim solution was to use a GPRS gateway. We have found that the GPRS modems tend to lock up after extended periods of time (2-4 days) and can be recovered only by cycling power to them. It seems that GPRS modems (we have tried GPRS modems from three different vendors) are generally not robust enough to run long-term outdoor applications. Further, our Internet Service Providers (ISP) do not provide public Internet Protocol (IP) addresses to the GPRS devices, which made remote troubleshooting more difficult. Our sensor network system has been operating independently since we changed the gateway to Asymmetric Digital Subscriber Line (ADSL) service on April 11th, 2007.

B. Results

1) *Dynamic Network Topologies:* After the deployment, we observed a highly dynamic network topology caused by the combination of many environmental parameters such as distance, antenna height, temperature, humidity and terrain.

Fig. 6 shows the most common network topology of our deployment, whose mean transmission range is around 855 meters. The arrows in the figure represent the direction of data flow. With the link quality aware routing protocol (surge reliable) introduced in Section III, the network stays in this topology more than 70% of time.

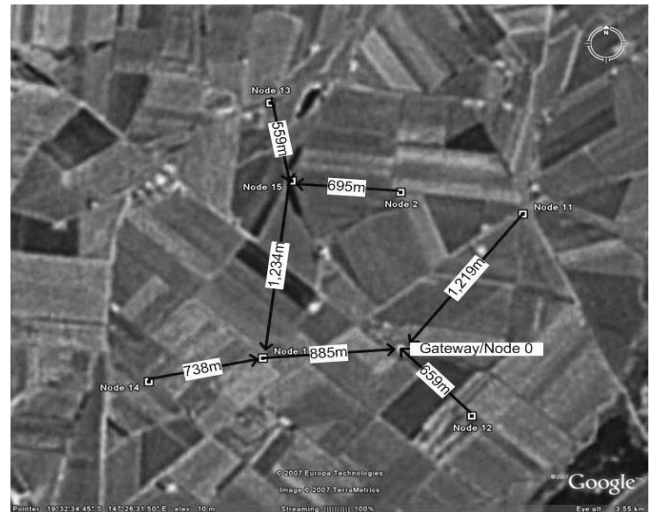

Fig. 6. The most common network topology. Mean transmission range: 855m.

Other than node 11, all of the nodes choose the geographically closest nodes as their intermediate parents. The distance between node 11 and node 2 is about 600 meters, and we observed the link between node 11 and node 2 when we did the transmission ranging test in December (when the sugar cane was 0.5 meters tall). Since deployment, we haven't observed the link between node 11 and node 2 when the sugar cane has been more than 4 meters tall (the heights of antennas are more than 5 meters). We observe very good link quality between

node 12 and node 0 (node 12 located in an open area). The link between Node 11 and Node 0 has intermittent connection only, and we plan to deploy an intermediate node between node 11 and node 0 to achieve more reliable radio link. The new link may also act as a router between node 2 and node 0.

Fig. 7 shows an extreme network topology of our deployment, whose mean transmission range is around 1,135 meters. In this scenario, most of the nodes (1, 2, 11, and 13) choose alternative longer distant parent nodes. Being closer to node 0 and located at an open spot makes the link quality between node 12 and 0 consistently good. Node 1 and node 11 chose node 12 as parent instead of transferring to node 0 directly in a few occasions.

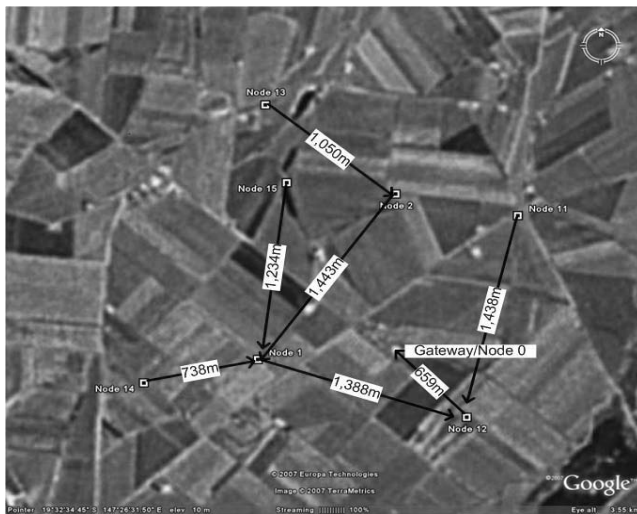

Fig. 7. An uncommon network topology. Mean transmission range: 1,135m.

2) *System Delivery rate*: Fig. 8 and Fig. 9 show the maximum/average/minimum recovery rates and delivery rates of the data collected over a period from 2007-04-18 to 2007-04-24. They show that the transport scheme of our system can improve the delivery rate up to 10.6% (on 2007-04-21). However, the minimum recovery rate is not significant (on average, around 0.05%) for the following reasons. First, if the communication link is stable, e.g. the link between 0 and 12, most data packets are delivered successfully by Surge Reliable and few transport layer retransmission happened. Second, if the communication link is unstable, we observed that surge reliable does not route downstream (from sink to nodes) well (in fact, by purely broadcasting and without hop-to-hop recovery). Consequently, source node, e.g., node 11, receives few NACK packets only, and therefore does not attempt retransmissions. While the first case shows that routing protocol proposed by research community works well in upstream (from nodes to sink) traffic, the second case shows some challenges needed to be solved for the downstream traffic. On average the delivery rate per day is about 66.33%.

Table II summaries the average delivery rates and average

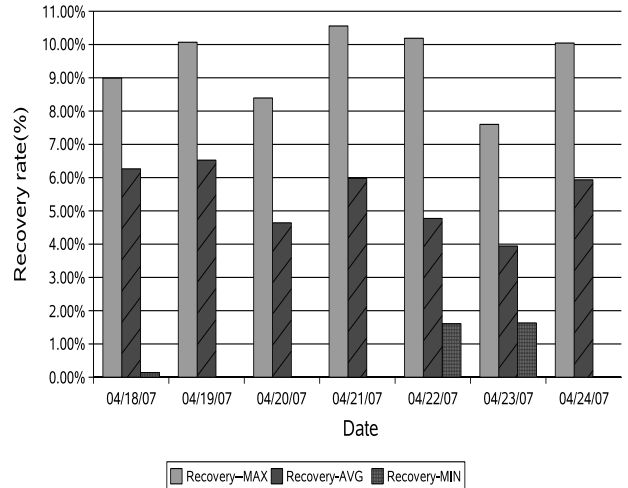

Fig. 8. Recovery rate

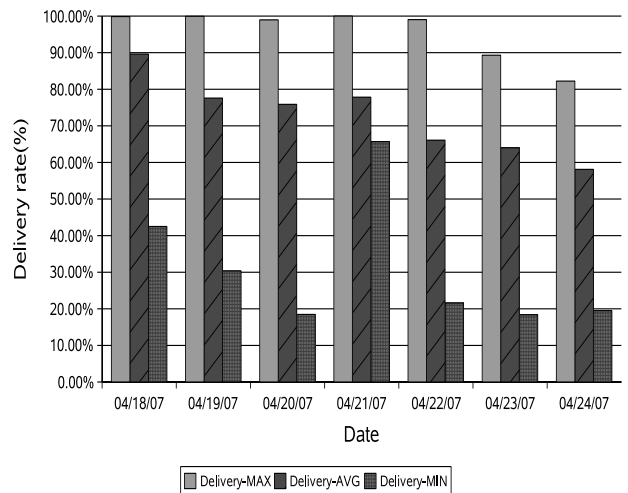

Fig. 9. Delivery rate

recovery rates each sensor node achieved for the entire week. In general, the average delivery rate per node is around 64% and the average recovery rate per node is around 5.4%. Note that the losses happened in the gateway (node 0 - 94.17% delivery rate) because the Transmission Control Protocol (TCP) connection between the gateway and server was down occasionally. Delivery rate of Node 12 (94.02%) is very close to the maximum delivery rate (node 0 - 94.17%). The delivery rate of node 11 is significantly lower (21.54%) because of the intermittent communication problem between node 11 and node 0 (see Section IV-B1). Therefore, we plan to deploy another effective networking node between node 11 and node 0.

We would also like to deploy another node between node 0 and node 1 to improve the robustness of the network in

TABLE II
THE AVERAGE DELIVERY RATE AND AVERAGE RECOVERY RATE FOR THE ENTIRE WEEK

Node ID	Delivery rate	Recovery rate
0	94.17%	3.54%
1	65.37%	4.49%
2	63.32%	6.67%
11	21.54%	4.13%
12	94.02%	4.62%
13	62.61%	6.5%
14	64.33%	6.83%
15	65.28%	5.87%

difficult environments, e.g., rain or the high humidity period before dawn. We study the impacts of link between node 0 and node 1 on the delivery rate. We calculated the time interval when the link between 0 and 1 is on, and estimated the delivery rate of each node between 2007-04-18 and 2007-04-24. Fig. 10 shows the average delivery rates that each node achieved. The results suggest that the expected delivery rate, when the link 0 and 1 is always on, is about 78.51%, which will be 14.51% more than it is currently (64%). This results will meet the transmission requirements, e.g., 75%, introduced in Section II.

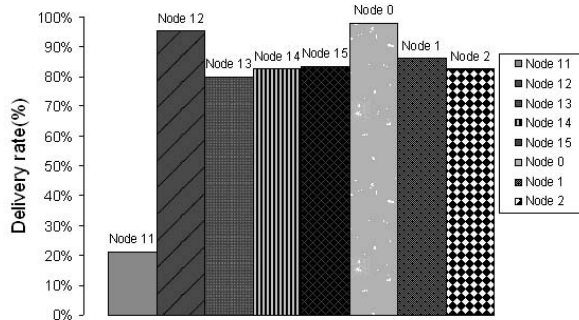

Fig. 10. The Average Delivery Rate over a week between 2007-04-18 and 2007-04-24 where the link 0-1 is always on

3) *Sensor Measurements:* Fig. 11 shows salinity, flow ticks, water level and flow rate sensor measurements of node 12 over 24 hours (2007-04-21 to 2007-04-22). It shows that the pump was turned on between 2007-04-21 9:24am to 2007-04-22 7:28am with a constant flow rate of 37.5 litre/second. As a result, the flow ticks incremented up to around 3,000,000 litres, and the water level decreased gradually from 2.95 meters to the ground to around 3.25 meters to the ground. Pumping water at 37.5 liter/second lowered the level of water table around node 12 by more than 30 cm in less than 24 hours! After the pump was turned off, which caused flow rate suddenly drop to the 0 (l/s) level, the level of water table gradually rose back to 2.95 meters depth. Fig. 11 shows that the salinity level was constantly at around 1,000 $\mu\text{S}/\text{cm}$ level. As the southern hemisphere is approaching winter (dry season in the tropical Burdekin area), we are expecting more

interesting water salinity results. The measurements collected from other nodes show similar phenomena, which suggests that the collected sensor reading is consistent, and useful for long term salinity and water table study.

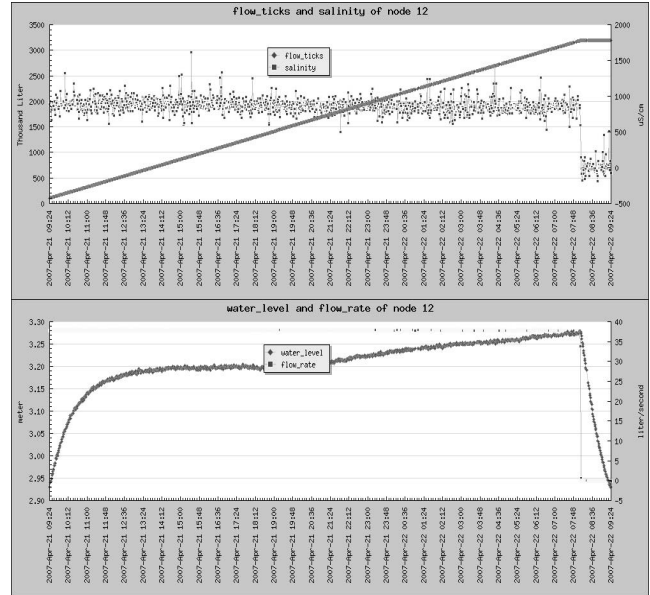

Fig. 11. Sensor Measurements of Node 12 between 2007-04-21 and 2007-04-22

C. Deployment lessons and Discussions

We discuss the lessons that we learned from the Burdekin remote water quality monitoring network deployment in this section.

Wireless radio transmissions. Wireless transmission model/range is an important parameter for both network protocol and network deployment design. Research community has well observed that “disc” transmission model is not applicable to most of wireless transmission scenarios. Our experience shows that network protocols such as [24] can operate well in dynamic (asymmetric links and changes of link quality/connectivity) environments. However, we failed to find any network deployment methodologies that can model the environment well, and produce high connectivity networks. In particular, the methodology should take the deployment parameters, such as terrains, humidity, and height of the antennas, into account on calculating the connectivities of radio links.

Routing support for down link traffic. Routing protocols such as [24] assumes that all the network traffics in sensor networks are toward one or a few gateways (sinks). Consequently, nodes store upstream (toward sinks) paths in their routing table only. Nodes have to use broadcast/flooding for downstream (toward sensors) traffic. Therefore, while the upstream traffic can be delivered efficiently, it is very inefficient to deliver downstream traffic, e.g., ACKs and NACKs. We observed very slow responses to the NACKs in our deployment, in particular

those nodes deep in the routing tree (e.g., node 2 and node 13 in Fig. 6). Nodes in routing protocols, such as Directed Diffusion [12], store bi-directional paths in their routing table. However, Directed Diffusion is not scalable with the number of traffic flows because intermediate nodes have to store the state of each flow that bypass them. The research community needs to address the downstream traffic problem in a scalable manner to improve the performance of reliable transmission protocols in the transport layer.

Robust Fleck and gateway. Because of inconvenient access (it takes more than 5 hours to travel from our lab to the Burdekin), remote sensor network deployment requires system engineers to take robustness into account at each component. We found out that a watchdog program is very helpful in remote deployments. The watchdog program resumes the operations of a fleck when an unforeseeable event happened, e.g., a software bug or unknown signals generated by environment noises crashes the software system. Further, the watchdog program can provide useful information, e.g., time, about the event that makes it easier to investigate and solve the program. Similarly, the watchdog logic in the remote gateway spared us from a few field trips.

V. RELATED WORK

Numerous sensor network applications have been proposed for applications such as habitat monitoring [2], [3], health [17], education [19], structure monitoring [16], automatic animal vocalization recognitions [11], [20], precision agriculture [9], [14], [21], [22] and the military [7], [15] in the past few years, where some of significant sensor network deployments are:

- Habitat Monitoring on Great Duck Island [2]: In the Spring of 2002, researchers from College of the Atlantic in Bar Harbor and the Berkeley began to deploy a wireless sensor network to monitor microclimates on Great Duck Island. More than 100 nodes have been deployed and millions of readings have been transferred to a central database thousands of kilometers away via wireless channels. Great duck island project is suspended currently.
- Scientists and engineers from UCLA and UCR have operated a 10 node, 100 microclimate sensor array at James Reserve over 12 months continuously [3]. Significant climate data has been stored in a database and is available for web queries. Apart from simple attributes like temperature, humidity, barometric pressure, and mid-range infrared, they are also collecting data from soil and video sources. They are extending the system to consist of more than 100 nodes and thousands of sensors for larger and deeper coverage.
- Belmont Cattle Station [8]: researchers from CSIRO have instrumented a cattle farm in Belmont, a remote area in Queensland, Australia, with static and mobile sensors. The static nodes measure properties such as soil moisture while the mobile nodes are carried by the livestock to study animal spatial behaviours. The nodes are solar powered, and have been operating independently about two years.
- Sensor Network Deployment for Precision Agriculture [14]: in June 2005, researcher from Delft University of Technology, the Netherlands began to deploy a sensor network with about 100 nodes to measure microclimates on an outdoor potato field. The project concerns a serious potato disease that has strong relation with microclimates in the field. The project did not go well, and the system managed to transfer 2% of data only. Instead, the project revealed a number of challenges overlooked by the sensor network research community previously.
- Industrial Sensornet Deployments [13]: Recently, two industrial sensornets have been deployed by the researchers and engineers from Intel and Arched Rock in a semiconductor plant and the North Sea oil field facility respectively. Sensornets are used to collect equipment vibration data for the purpose of preventative maintenance.
- Active Volcano Monitoring [23]: In the Summer of 2005, researchers from USA and Ecuador deployed a 16-node network, equipped with seismic and acoustic sensors, on Volcan Reventador, an active volcano in northern Ecuador. The sensornet was deployed over a three-kilometer area. Sensor data were routed over a multi-hop network to a long-distance base station, in where the data were logged and analyzed. The sensornet was deployed for a period of three weeks, and more than 200 events were detected within the period.
- Researchers from University of Hawaii have deployed a 60-node sensor network at Hawaii Volcanoes National Park, Hawaii Island, Hawaii, USA [6]. The goal of the sensornet is to study rare and endangered species of plants, by monitoring the plants using video sensors and their environment using microclimate sensors. Each node is a computer, which uses Wi-Fi as MAC protocol. Data is delivered using IP packets.
- FireWxNet [10]: to provide fire fighting community the ability to monitor fire and weather conditions over a wide range of locations, researchers from University of Colorado, Boulder and University of Montana have deployed a portable multi-tiered wireless sensor network to monitor weather conditions in bush areas. FireWxNet consists of two tiers: video sensor (camera) tier and mote tier with microclimate sensors such as temperature and humidity. Microclimate data are used to analyse the behaviours of fire, and video data are used to verify analysed results. 3 notes and 2 cameras were deployed in the Selway-Salmon Complex Fires of 2005 for 5 days, and have collected large amount of microclimate and video data.

Most of previous sensor network deployments focus on indoor environments and computer system (network protocol in particular) study. While these deployments can provide unprecedented fine-grained environmental data for scientific research, to the best of our knowledge, few sensor network has been deployed for long-term outdoor industrial applications. Further, limited success has been achieved by previous outdoor industrial application sensornet deployments [14].

Our Burdekin sensor network deployment aims to provide a feasible solution for a critical problem (water salination) to an industrial partner, e.g., North Burdekin Water Broad, by deploying a robust system, which can operate independently for a long term, in harsh remote outdoor environment.

VI. CONCLUSION AND FUTURE WORK

In this paper, we investigate a water quality sensor network *deployment* in a remote tropical area of northern Australia. Our goal is to collect real time water quality measurements together with the amount of water being pumped out of the area, and investigate the impacts of current irrigation practice to the environment, in particular underground water salination.

This is a challenging task featuring wide geographic network coverage, highly dynamic radio transmissions, high end-to-end packet delivery rate requirements, and hostile system deployment environments. We have designed, implemented and deployed a sensor network system, which has been collecting water quality measurements since early April 2007. The preliminary results show that sensor networks can provide a solution to deploy a sustainable irrigation system, e.g., maximizing the amount of water pumped out from an area with minimum impact on water quality.

We plan to deploy two more nodes to improve the connectivity of our network; one between node 0 and node 11, and the other between node 0 and node 1. Further, we are enabling the flash memory of fleck to provide a significantly larger buffer that allows the system to handle network outage better. Next, having validated our system design, we plan to deploy 20 more nodes so that our network can cover a larger area. Once the aquifer system is better understood, our ultimate target is to optimise the extraction in real-time by making decisions about when and where to pump with the objective of minimising saltwater intrusion.

ACKNOWLEDGMENT

The authors would like to thank Peter Fitch, John Whitham for their supports; Water Resource Observation Networks (WRON) for the funding supports; North Burdekin Water Board for their collaborations on this project.

REFERENCES

- [1] *CSIRO Land and Water*. <http://www.clw.csiro.au/>.
- [2] Habitat monitoring on great duck island. <http://www.greatduckisland.net/index.php>.
- [3] Habitat monitoring on james reserve. <http://www.jamesreserve.edu/>.
- [4] Outdoor sensor network deployment in belmont. <http://www.sensornets.csiro.au/belmont.htm>.
- [5] Tinyos <http://www.tinyos.net/>.
- [6] E. Biagioni and K. Bridges. The application of remote sensor technology to assist the recovery of rare and endangered species. *International Journal of High Performance Computing Applications*, 16:315–324, 2005.
- [7] R. Chellappa, G. Qian, and Q. Zheng. Vehicle detection and tracking using acoustic and video sensors. In *Proceedings of the International Conference on Acoustics, Speech and Signal Processing*, Montreal, Canada, May 2004.
- [8] P. Corke, P. Valencia, P. Sikka, T. Wark, and L. Overs. Long-duration solar-powered wireless sensor networks. In *Fourth Workshop on Embedded Networked Sensors*, Cork, Ireland, 2007.

- [9] D. Estrin, L. Girod, G. Pottie, and M. Srivastava. Instrumenting the world with wireless sensor networks. In *Proceedings of the International Conference on Acoustics, Speech and Signal Processing*, Salt Lake City, Utah, May 2001.
- [10] C. Hartung, R. Han, C. Seielstad, and S. Holbrook. Firewxnet: a multi-tiered portable wireless system for monitoring weather conditions in wildland fire environments. In *MobiSys 2006: Proceedings of the 4th international conference on Mobile systems, applications and services*, pages 28–41, New York, NY, USA, 2006. ACM Press.
- [11] W. Hu, V. N. Tran, N. Bulusu, C. T. Chou, S. Jha, and A. Taylor. The design and evaluation of a hybrid sensor network for cane-toad monitoring. In *IPSN '05: Proceedings of the 4th international symposium on Information processing in sensor networks*, page 71, Piscataway, NJ, USA, 2005. IEEE Press.
- [12] C. Intanagonwivat, R. Govindan, D. Estrin, J. Heidemann, and F. Silva. Directed diffusion for wireless sensor networking. *IEEE/ACM Transactions on Networking (TON)*, 11(1):2–16, 2003.
- [13] L. Krishnamurthy, R. Adler, P. Buonadonna, J. Chhabra, M. Flanigan, N. Kushalnagar, L. Nachman, and M. Yarvis. Design and deployment of industrial sensor networks: experiences from a semiconductor plant and the north sea. In *SenSys '05: Proceedings of the 3rd international conference on Embedded networked sensor systems*, pages 64–75, New York, NY, USA, 2005. ACM Press.
- [14] K. Langendoen, A. Baggio, and O. Visser. Murphy loves potatoes: Experiences from a pilot sensor network deployment in precision agriculture. In *14th Int. Workshop on Parallel and Distributed Real-Time Systems (WPDRTS)*, 2006.
- [15] A. Ledeczi, P. Volgyesi, M. Maroti, G. Simon, G. Balogh, A. Nadas, B. Kusy, S. Dora, and G. Pap. Multiple simultaneous acoustic source localization in urban terrain. In *IPSN '05: Proceedings of the 4th international symposium on Information processing in sensor networks*, page 69, Piscataway, NJ, USA, 2005. IEEE Press.
- [16] K. Mechtov, W. Kim, G. Agha, and T. Nagayama. High-frequency distributed sensing for structure monitoring. In *Proceedings of the First International Workshop on Networked Sensing Systems*, Tokyo, Japan, June 2004.
- [17] L. Schwiebert, S. K. Gupta, and J. Weinmann. Research challenges in wireless networks of biomedical sensors. In *Proceedings of the 7th ACM MOBICOM*, pages 151–165, Rome, Italy, July 2001. ACM Press.
- [18] P. Sikka, P. Corke, and L. Overs. Wireless sensor devices for animal tracking and control. In *1st EmNets*, pages 446–454, 2004.
- [19] M. Srivastava, R. Muntz, and M. Potkonjak. Smart kindergarten: sensor-based wireless networks for smart developmental problem-solving environments. In *Proceedings of the 7th ACM MOBICOM*, pages 132–138, Rome, Italy, July 2001. ACM Press.
- [20] H. Wang, D. Estrin, and L. Girod. Preprocessing in a tiered sensor network for habitat monitoring. *EURASIP JASP special issue of sensor networks*, pages 392 – 401, 2003.
- [21] T. Wark, P. Corke, P. Sikka, L. Klingbeil, Y. Guo, C. Crossman, P. Valencia, D. Swain, and G. Bishop-Hurley. Transforming agriculture through pervasive wireless sensor networks. *IEEE Pervasive Computing*, 6(2):50–57, 2007.
- [22] T. Wark, C. Crossman, W. Hu, Y. Guo, P. Valencia, P. Sikka, P. Corke, C. Lee, J. Henshall, K. Prayaga, J. O'Grady, M. Reed, and A. Fisher. The design and evaluation of a mobile sensor/actuator network for autonomous animal control. In *IPSN '07: Proceedings of the 6th international conference on Information processing in sensor networks*, pages 206–215, New York, NY, USA, 2007. ACM Press.
- [23] G. Werner-Allen, K. Lorincz, M. Ruiz, O. Marcillo, J. Johnson, J. Lees, and M. Welsh. Deploying a wireless sensor network on an active volcano. *To appear in special Sensor Nets issue of IEEE Internet Computing*, early 2006.
- [24] A. Woo, T. Tong, and D. Culler. Taming the underlying challenges of reliable multihop routing in sensor networks. In *SenSys '03: Proceedings of the 1st international conference on Embedded networked sensor systems*, pages 14–27. ACM Press, 2003.